



MVE Biological Solutions for Life Sciences

Storage & Transport Systems for MVE Cryopreservation





Americas

Customer Service:

+1-844-683-2796

customerservice.usa@mvebio.com

breeders.cs@mvebio.com

EMEA

Customer Service:

+44 7718 488236

customerservice.europe@mvebio.com

breeders.europe@mvebio.com

China (Domestic)

Customer Service:

+86 28 6572 9660

Jessy Yang – Direct: +86 28 6572 9668

customerservice.china@mvebio.com

Asia Pac Rim

Customer Service: +01 404-383-1900

csasia@mvebio.com

Australia & New Zealand

Customer Service:

+01 404-383-1900

MVE.Australia@mvebio.com

Technical Service

Technical Service:

+01 404 383-1900

techservice@mvebio.com

**Visit www.mvebio.com
for more information.**

© 2024 MVE Biological Solutions reserves the right to discontinue its products, or change the prices, materials, equipment, quality, descriptions, specifications and/or processes to its products at any time without prior notice and with no further obligation or consequence. All rights not expressly stated herein are reserved by us, as applicable.

Contents

○ Temperature Chart & Product Selector Guide	2
○ MVE Fusion® Series	3
○ MVE TS (Touch Screen)	5
○ MVE HEco™ 800 Series Freezers	7
○ MVE HEco™ 1500 Series Freezers	9
○ MVE HEco™ 1800 Series Freezers	11
○ MVE High Efficiency 800 -190°C Series	13
○ MVE High Efficiency 1500 -190°C Series	15
○ MVE High Efficiency 1800 -190°C Series	17
○ MVE Variō® Series Freezers	19
○ MVE Series	21
○ MVE 816P-2T-190	23
○ MVE Stock Series	25
○ MVE CryoCart	27
○ MVE Research Dewars	29
○ MVE CryoSystem 6000 Full Auto	31
○ MVE CryoSystem Series	33
○ MVE Lab Series	35
○ MVE SC Series	37
○ MVE XC Series	39
○ MVE Doble Series	41
○ MVE CryoCube™ & BL-7	43
○ MVE Blood Bag Shippers CT-50 and CT-250	45
○ MVE Vapor Shipper Series	47
○ Data Logger	49
○ MVE 1536 Dry Shipper	51
○ MVE CryoTipper	53
○ Notes	55

Temperature Chart

MVE Biological Solutions is the leading global manufacturer of cryogenic storage and shipping devices. More than 60 years ago, we set the standard for storage of biological materials at low temperatures. Today, we continue to exceed these standards. Customers from around the world look to MVE for excellence and innovation, and we continue to make a vital contribution in today's biomedical Life Sciences industry. In this manner, MVE continues to make a vital contribution in today's biomedical Life Sciences industry.

Maximum temperature for storage of biological samples.

MATERIAL TO BE STORED	VOLUME	CONTAINER	INVENTORY CONFIGURATION	CRITICAL TEMPERATURE
○ Algae	0.5 - 1.0 mL	Cryovial	Boxes or canes	-150°C
- Blood	0.5 - 500 mL	Cryovial/Blood Bag	Boxes or canes/bag rack	-150°C
○ Cells:				
- Animals / Human	0.5 - 1.0 mL	Cryovial	Boxes or canes	-150°C
- Plant	0.5 - 1.0 mL	Cryovial	Boxes or canes	-150°C
- Embryos		Straw	Canes	-150°C
○ Fungi:				
- Mycelium	0.5 - 1.0 mL	Cryovial	Boxes or canes	-150°C
○ Hybridomas	0.5 - 1.0 mL	Cryovial	Boxes or canes	-150°C
○ Phage:	16.00 (406)	16.00 (406)	20.70 (527)	25.13 (638)
- Libraries	0.5 - 1.0 mL	Cryovial	Boxes or canes	-150°C
- Protozoa	0.5 - 1.0 mL	Cryovial	Boxes or canes	-150°C
○ Viruses: Animal In Cells	0.5 - 1.0 mL	Cryovial	Boxes or canes	-150°C

Product Selector Guide

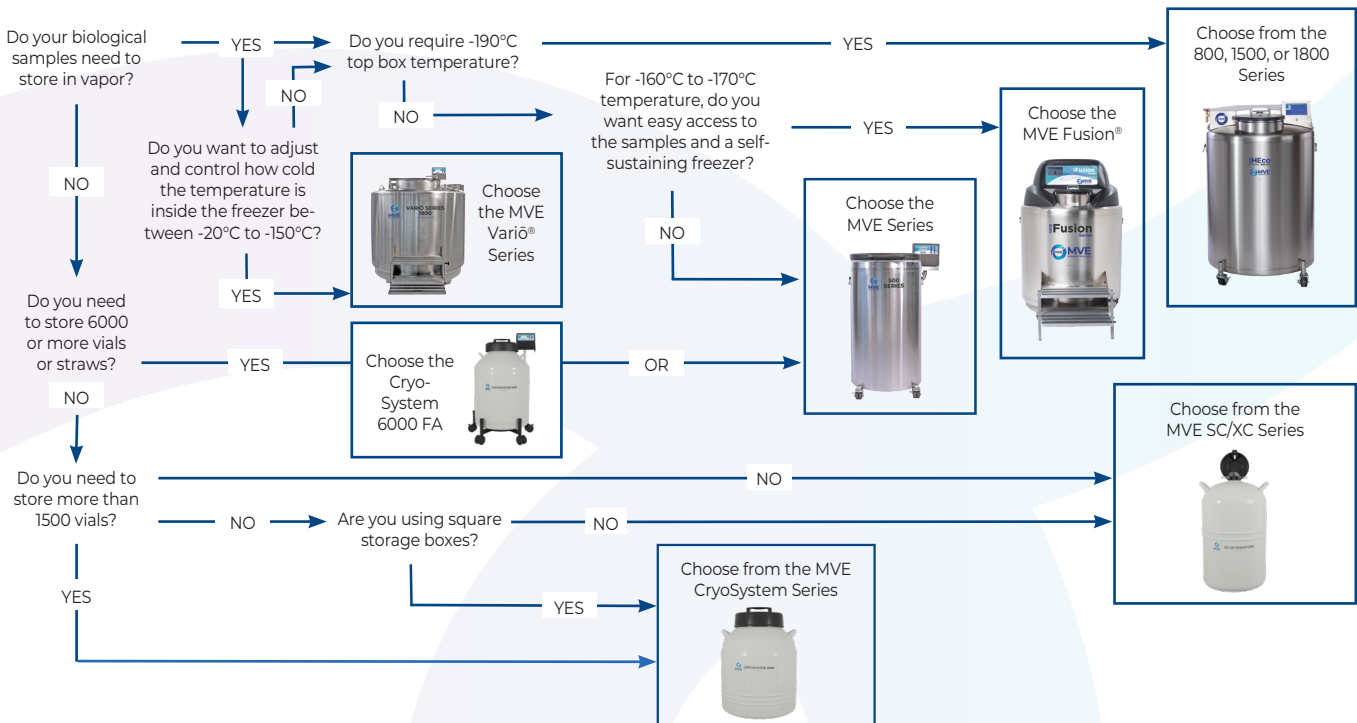

ML-000019 Ver1

MVE Fusion® Freezer

Self-sustaining cryogenic freezer

Satisfying the need to minimize or obsolete liquid nitrogen infrastructure, MVE created the MVE Fusion Freezer, the world's first self-sustaining cryogenic freezer. The MVE Fusion is a refrigerated liquid-based bio-storage freezer, similar in appearance and construction to an MVE High Efficiency LN₂ freezer. The MVE Fusion is designed to provide cold storage capabilities, with no need for regular ongoing liquid nitrogen supply source. The MVE Fusion can be used in remote locations, isolated rooms, high elevation facilities, and facilities with little or no vacuum jacketed pipe infrastructures. The MVE Fusion does not require constant LN₂ supply.

Key Features

- Self-sustaining
- Dry sample storage
- Low liftover height
- Two tier folding step



MVE Fusion® Freezer

Maximum Storage Capacity

○ 1.2 & 2 ml Vials (Internally Threaded)	31,200
○ Number of Racks 100 cell boxes	20
○ Number of Racks 25 cell boxes	16
○ Number of Stages per Rack	13

Performance

○ LN ₂ Capacity L	50 (inner pressure vessel)
------------------------------	----------------------------

Unit Dimensions

○ Neck Opening in. (mm)	12.5 (318)
○ Usable Internal Height in. (mm)	29.6 (752)
○ Inner Diameter in. (mm)	38.4 (975)
○ Overall Height in. (mm)	65 (1625)
○ Overall Depth in. (mm)	57 (1450)
○ Liftover Height in. (mm)	37.1 (944)
○ Door Width Requirement** in. (mm)	43.5 (1105) with handles
○ Weight Empty est. lb. (kg)	750 (340) estimated
○ Weight Liquid Full* (Freezer with 50L and Cryocooler) est. lb. (kg)	830 (377) without racks estimated

Blood Bag Capacities

	Total Bags	Bags/Frame	No. Frames
○ 791 OS/U (25 ml)	2296	7	328
○ 4R9951 (50 ml)	1484	7	212
○ 4R9953 (250 ml)	752	4	188
○ 4R9955 (500 ml)	592	4	148
○ DF200 (200 ml)	416	4	104
○ DF700 (700 ml) (will not fit through neck opening)			

FIVE Year Vacuum Warranty • TWO Year Standard Warranty

* Without inventory

**Minimum width required for vessel to pass through opening. Footprint may vary. Contact Tech Service for detailed drawings. Conforms to MDD 93/42/EEC, the Medical Device Directive for the EU. Freezer systems UL/C-UL Listed.

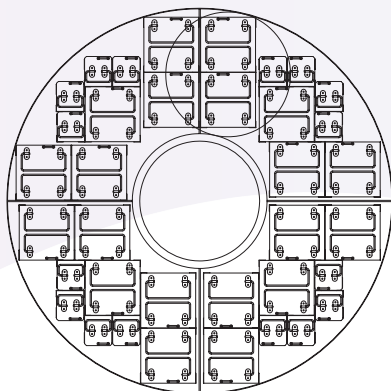

Rack Layout

MVE TS (Touch Screen)

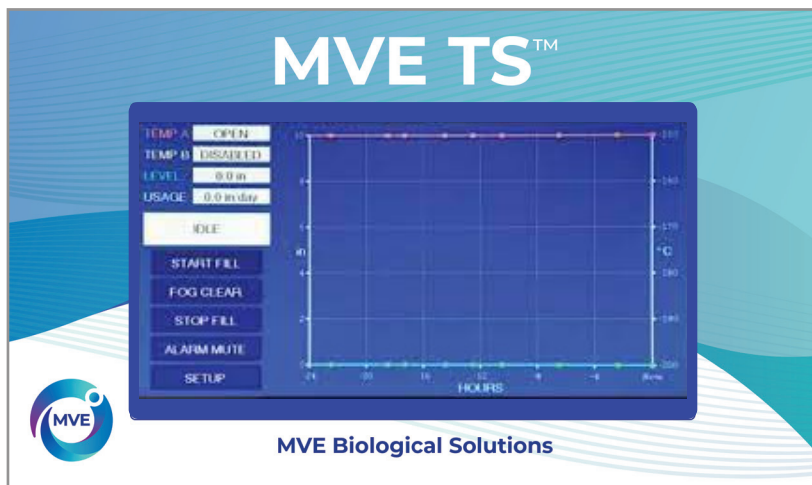

Key Features

- MVE TS employs a variety of advanced features that enable the controller to monitor and control the environment inside a freezer with a high level of precision.
- The new screen features X, Y graph for quick view of temperature and liquid nitrogen level!

Liquid Nitrogen Level Measurement

MVE TS uses a differential pressure system to determine the LN₂ level to an accuracy of ± 0.5 in. (15 mm) and a resolution of 0.1 in. (5.0 mm). Unlike alternative level sensing systems, differential pressure allows the exact level to be measured and displayed. Using the simple single point calibration in a range of 3.0 in. to 48.0 in. (75 mm to 1220 mm), the self-maintaining, closed-loop system displays in inches, millimeters, or a percentage full.

Automatic Liquid Nitrogen Level Control

The fully automated LN₂ level control system is based on user-defined parameters that can be electronically adjusted over the entire level range. The parameters include Low Level Alarm, Low Level Fill Point, High Level Fill Point and High Level Alarm. The redundant Dual Solenoid Valves for overflow protection run on 24 VDC, 1.0 amp (max).

Liquid Usage

This feature provides an estimation of liquid usage to track LN₂ consumption and can provide an early failure warning to allow sufficient time to implement corrective action and save irreplaceable samples.

User-Defined Alarms

A total of 18 audio/visual alarms are used to alert the user to any potential or developing problems. The alarms include: High Temperatures, Low Temperatures, High Level, Low Level, Liquid Usage, Maximum Fill Time, Gas Bypass, Stuck Open/Closed, Temperature Calibrations, Low Battery, Power Failure, Lid Open and Communication Loss.

Remote Alarm Monitoring

Alarm monitoring includes Global/Discrete Remote Alarm Relay.

MVE TS (Touch Screen)

Temperature Measurement

Two independent temperature measurement channels are employed to accurately measure the temperature across the entire storage space. The two platinum RTD sensors have an accuracy of $\pm 1.0^{\circ}\text{C}$ and a resolution of 0.1°C . The temperature can be displayed in $^{\circ}\text{C}$, $^{\circ}\text{F}$ or K. The single or two point calibration also has altitude compensation for the highest accuracy.

Temperature Inlet Settings (Hot Gas Bypass)

This unique feature is able to vent warm nitrogen gas from the supply line before initiating a fill. This prevents warm gas from entering the freezer space, which helps maintain a stable temperature gradient and increases the efficiency by reducing excess LN_2 evaporation.

Event Log / Data Storage

Store vital, unalterable, time-stamped data in nonvolatile memory. This is a great tool for assessing

freezer performance and troubleshooting any problems. The memory can store 30,000 events, an estimated 10 years of storage capacity. The data includes time-stamped temperatures, LN_2 level, liquid usage, and any alarms or events.

Password Security

The multilevel security system comprised of up to ten user-specific programmable passwords and four security levels can be customized to grant or restrict personnel access to certain menus and settings.

Communication Capabilities

ONE independent port can be used to communicate with other MVE TS controllers, a remote PC, serial printer, or other RS-485 networks and devices. Options include ASCII, MODBUS, Printer and One Fill All Fill (OFAF).

Ethernet Capabilities

One independent RJ45 port can be used for network connection.

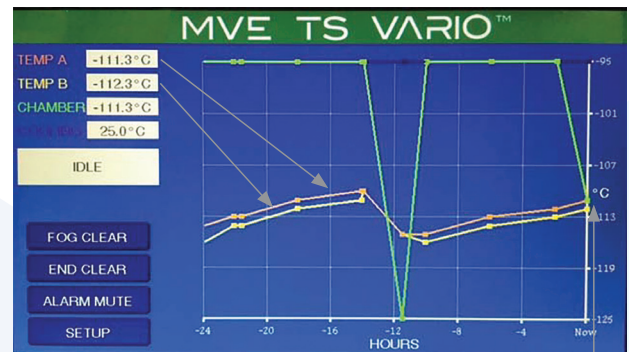
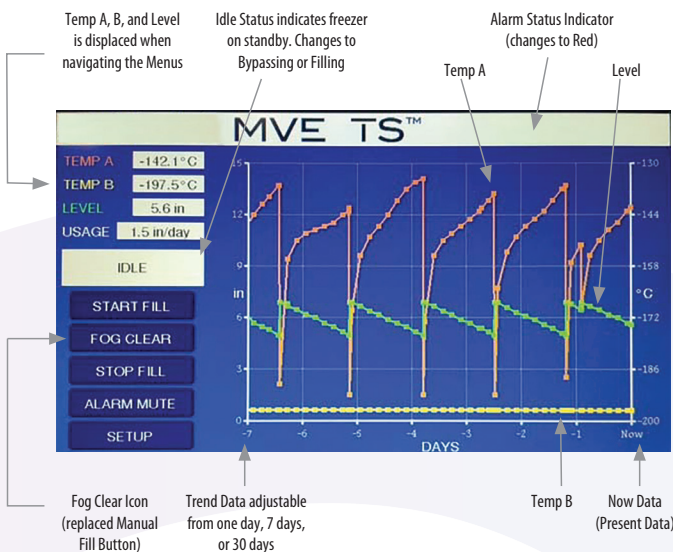



MVE HEco™ 800 Series

Available with the MVE Touch Screen & TEC 3000

The MVE HEco Series is the next generation High Efficiency freezer from MVE. With their unique shroud design, streamlined LN₂ plumbing, and vacuum jacketed transfer hose, the MVE HEco 800 Series freezers provide efficient use of LN₂, making them highly efficient. These next generation high efficiency freezers incorporate hinged work surfaces that fully enclose all electronics and plumbing to enhance overall safety and usability.

The technical and visual improvements combine to create a more aesthetically pleasing freezer that offers greater functionality. As with all of MVE's cryogenic freezers, the MVE HEco 800 Series freezers are available in three unique sizes and provide storage density as well as long hold times and high sample security.

Key Features

- LN₂ efficiency
- Fully enclosed wiring and plumbing
- Vacuum jacketed transfer hose
- Dry sample storage
- -190°C top box temperature
- Low liftover height
- Single step standard
- Optional double-tier step

Rack Layout

Square Rack Layout (P)

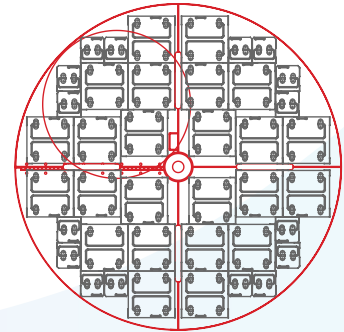

4R9951 Layout (R)

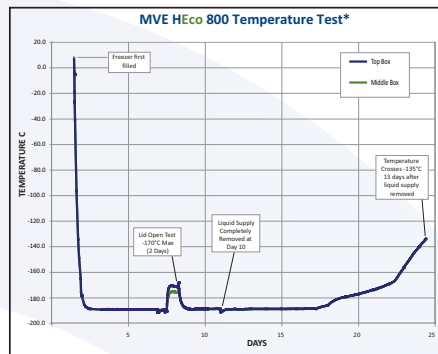
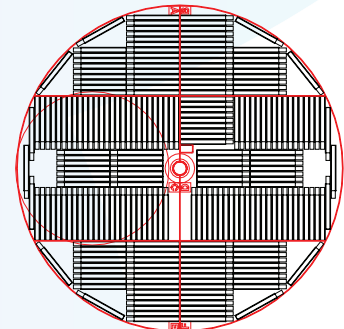

Temperature Test Graph

* Temperature test indicates typical performance of HEco Series freezer with full inventory system and factory recommended level settings. Actual performance may vary with atmospheric conditions and usage.

MVE HEco™ 800 Series

	MVE HEco 815P-190	MVE HEco 818P-190	MVE HEco 819P-190						
Maximum Storage Capacity									
○ 1.2 & 2 ml Vials (Internally Threaded)	15,600	18,200	19,500						
○ Quantity of Large Racks 100 cell boxes	12	12	12						
○ Quantity of Mini Racks 25 cell boxes	4	4	4						
○ Number of Shelves per Rack	12	14	15						
Performance									
○ LN ₂ Capacity at Vapor Platform L est.	62	55	55						
○ LN ₂ Capacity w/o Inventory L est.	360	403	446						
Unit Dimensions									
○ Neck Opening in. (mm)	12.5 (317)	12.5 (317)	12.5 (317)						
○ Usable Internal Height in. (mm)	26.5 (673)	30.7 (781)	34.5 (877)						
○ Inner Diameter in. (mm)	28.8 (731)	28.8 (731)	28.8 (731)						
○ Overall Height in. (mm) TS Model	53.1 (1350)	53.9 (1370)	57.70 (1465)						
○ Liftover Height in. (mm)	41 (1038)	43.8 (1115)	47.63 (1209)						
○ Door Width Requirement** in. (mm)	32.0 (813)	32.0 (813)	32.0 (813)						
○ Door Width Requirement, with handles** in. (mm)	33.2 (843)	33.2 (843)	33.2 (843)						
○ Weight Empty* lb. (kg)	480 (218)	495 (225)	515 (234)						
○ Weight Liquid Full* lb. (kg) est.	1160 (526)	1168 (530)	1340 (608)						
Blood Bag Capacities									
	Total Bags	Bags/ Frame	No. Frames	Total Bags	Bags/ Frame	No. Frames	Total Bags	Bags/ Frame	No. Frames
○ 791 OS/U Medsep (25 ml)	1,224	6	204	1428	7	204	1,836	9	204
○ 4R9951 (50 ml)	768	6	128	896	7	128	1024	8	128
○ 4R9953 (250 ml)	416	4	104	416	4	104	520	5	104
○ 4R9955 (500 ml)	304	4	76	304	4	76	380	5	76
○ DF200 (200 ml)	236	4	59	236	4	59	295	5	59

FIVE Year Vacuum Warranty - TWO Year Parts Warranty

* Without inventory

**Minimum width required for vessel to pass through opening. Footprint may vary. Contact Tech Service for detailed drawings.

*** The TEC 3000 Conforms to MDD 93/42/EEC, the Medical Device Directive for the EU. Freezer systems UL/C-UL Listed.

MVE HEco™ 1500 Series

Available with the MVE Touch Screen & TEC 3000

The MVE HEco Series is the next generation High Efficiency freezer from MVE. With their unique shroud design, streamlined LN₂ plumbing, and vacuum jacketed transfer hose, the MVE HEco 1500 Series freezers provide efficient use of LN₂, making them highly efficient. These next generation high efficiency freezers incorporate hinged work surfaces that fully enclose all electronics and plumbing to enhance overall safety and usability.

The technical and visual improvements combine to create a more aesthetically pleasing freezer that offers greater functionality. As with all of MVE's cryogenic freezers, the MVE HEco 1500 Series freezers are available in three unique sizes and provide storage density as well as long hold times and high sample security.

Key Features

- LN₂ efficiency
- Fully enclosed wiring and plumbing
- Vacuum jacketed transfer hose
- Dry sample storage
- -190°C top box temperature
- Low liftover height
- Two-tier folding step

Rack Layout

Square Rack Layout (P)

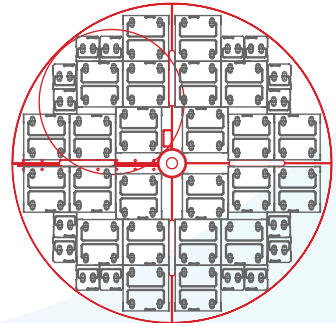

4R9951 Layout (R)

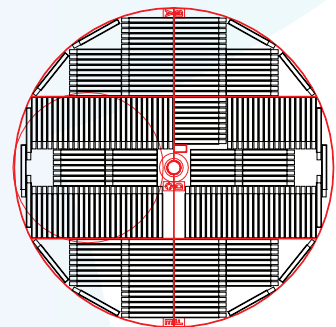

MVE HEco™ 1500 Series

	MVE HEco 1536P-190	MVE HEco 1539P-190	MVE HEco 1542R-190						
Maximum Storage Capacity									
○ 1.2 & 2 ml Vials (Internally Threaded)	36,400	39,200	42,000						
○ Quantity of Large Racks 100 cell boxes	24	24	26						
○ Quantity of Mini Racks 25 cell boxes	16	16	16						
○ Number of Shelves per Rack	13	14	14						
Performance									
○ LN ₂ Capacity at Vapor Platform L est.	133	133	133						
○ LN ₂ Capacity w/o Inventory L est.	756	797	797						
Unit Dimensions									
○ Neck Opening in. (mm)	17.4 (442)	17.4 (442)	17.4 (442)						
○ Usable Internal Height in. (mm)	28.7 (730)	30.2 (767)	30.8 (782)						
○ Inner Diameter in. (mm)	38.5 (978)	38.5 (978)	38.5 (978)						
○ Overall Height in. (mm) TS Model	54.7 (1389)	56.8 (1442)	56.8 (1442)						
○ Liftover Height in. (mm)	37.3 (947)	39.4 (999)	39.4 (999)						
○ Door Width Requirement** in. (mm)	42.0 (1067)	42.0 (1067)	42.0 (1067)						
○ Door Width Requirement, with handles** in.(mm)	43.3 (1099)	43.3 (1099)	43.3 (1099)						
○ Weight Empty* lb. (kg)	700 (318)	700 (318)	700 (318)						
○ Weight Liquid Full* lb. (kg) est.	2000 (907)	2100 (953)	2100 (953)						
Blood Bag Capacities									
	Total Bags	Bags/ Frame	No. Frames	Total Bags	Bags/ Frame	No. Frames	Total Bags	Bags/ Frame	No. Frames
791 OS/U Medsep (25 ml)	2,905	7	415	3,320	8 †	415	3,184	8 †	398
4R9951 (50 ml)	1,488	6	248	1,736	7	248	1,687	7	241
4R9953 (250 ml)	812	4	203	812	4	203	768	4	192
4R9955 (500 ml)	608	4	152	608	4	152	576	4	144
DF200 (200 ml)	496	4	124	496	4	124	488	4	122
DF700 (700 ml)	256	4	64	256	4	64	264	4	66

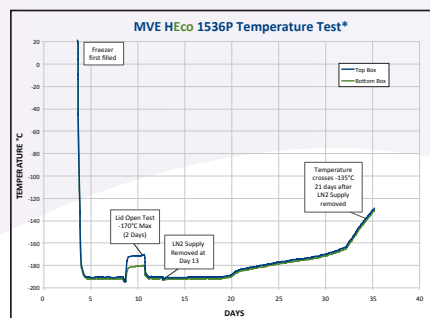

FIVE Year Vacuum Warranty • TWO Year Parts Warranty

* Without inventory

**Minimum width required for vessel to pass through opening. Footprint may vary. Contact Tech Service for detailed drawings.

*** The TEC 3000 Conforms to MDD 93/42/EEC, the Medical Device Directive for the EU. Freezer systems UL/C-UL Listed.

† Between usable height and clearance. Please refer to specifications.

Temperature Test Graph

* Temperature test indicates typical performance of HEco Series freezer with full inventory system and factory recommended level settings. Actual performance may vary with atmospheric conditions and usage.



MVE HEco™ 1800 Series

Available with the MVE Touch Screen & TEC 3000

The MVE HEco Series is the next generation High Efficiency freezer from MVE. With their unique shroud design, streamlined LN₂ plumbing, and vacuum jacketed transfer hose, the MVE HEco 1800 Series freezers provide efficient use of LN₂, making them highly efficient. These next generation high efficiency freezers incorporate hinged work surfaces that fully enclose all electronics and plumbing to enhance overall safety and usability.

The technical and visual improvements combine to create a more aesthetically pleasing freezer that offers greater functionality. As with all of MVE's cryogenic freezers, the MVE HEco 1800 Series freezers are available in three unique sizes and provide storage density as well as long hold times and high sample security.

Key Features

- LN₂ efficiency
- Fully enclosed wiring and plumbing
- Vacuum jacketed transfer hose
- Dry sample storage
- -190°C top box temperature
- Low lift-over height
- Two-tier folding step

Rack Layout

Square Rack Layout (P)

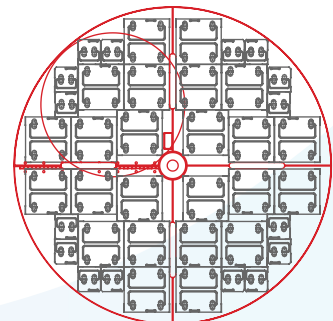

4R9951 Layout (R)

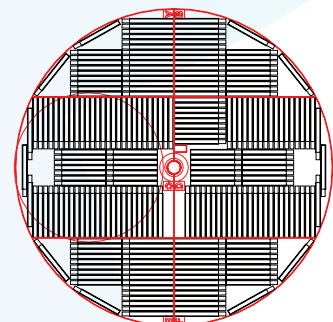

MVE HEco™ 1800 Series

	MVE HEco 1879P-190	MVE HEco 1881R-190	MVE HEco 1892P-190	MVE HEco 1894R-190								
Maximum Storage Capacity												
○ 1.2 & 2 ml Vials (Internally Threaded)	79,950	81,900	92,250	94,500								
○ Quantity of Large Racks 100 cell boxes	54	60	54	60								
○ Quantity of Mini Racks 25 cell boxes	30	12	30	12								
○ Number of Shelves per Rack	13	13	15	15								
Performance												
○ LN ₂ Capacity at Vapor Platform L est.	292	305	282	300								
○ LN ₂ Capacity w/o Inventory L est.	1516	1521	1737	1732								
Unit Dimensions												
○ Neck Opening in. (mm)	25 (635)	25 (635)	25 (635)	25 (635)								
○ Usable Internal Height in. (mm)	29.5 (749)	29.2 (741)	34.5 (876)	34.2 (868)								
○ Inner Diameter in. (mm)	56.0 (1422)	54.8 (1391)	56.0 (1422)	54.7 (1389)								
○ Overall Height in. (mm) TS Model	63.7 (1618)	63.7 (1618)	68.6 (1742)	68.6 (1742)								
○ Liftover Height in. (mm)	38.8 (985)	38.8 (985)	44.0 (1118)	44.0 (1118)								
○ Door Width Requirement** in. (mm)	60.0 (1524)	60.0 (1524)	60.0 (1524)	60.0 (1524)								
○ Weight Empty* lb. (kg)	1721 (781)	1721 (781)	1721 (781)	1721 (781)								
○ Weight Liquid Full* lb. (kg) est.	4830 (2191)	4830 (2191)	4875 (2211)	4875 (2211)								
Blood Bag Capacities												
	Total Bags	Bags/ Frame	No. Frames	Total Bags	Bags/ Frame	No. Frames	Total Bags	Bags/ Frame	No. Frames	Total Bags	Bags/ Frame	No. Frames
791 OS/U Medsep (25 ml)	5,866	7	838	5,628	7	804	6,704	8	838	6,432	8	804
4R9951 (50 ml)	2,952	6	492	2,940	6	490	3,936	8	492	3,920	8	490
4R9953 (250 ml)	1,584	4	396	1,608	4	402	1,980	5	396	2,010	5	402
4R9955 (500 ml)	1,104	4	276	1,240	4	310	1,380	5	276	1,550	5	310
DF200 (200 ml)	960	4	240	984	4	246	1,200	5	240	1,230	5	246
DF700 (700 ml)	504	4	126	544	4	136	630	5	126	680	5	136

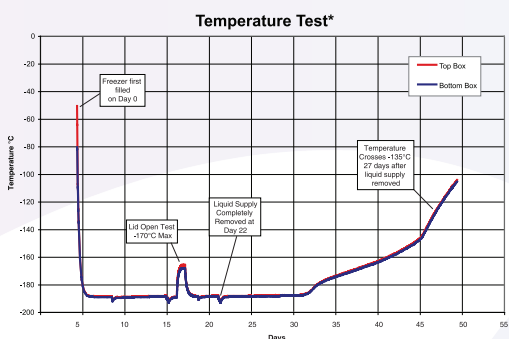

FIVE Year Vacuum Warranty • TWO Year Parts Warranty

* Without inventory

** Minimum width required for vessel to pass through opening. Footprint may vary. Contact Tech Service for detailed drawings.

*** The TEC 3000 Conforms to MDD 93/42/EEC, the Medical Device Directive for the EU. Freezer systems UL/C-UL Listed.

Temperature Test Graph

* Temperature test indicates typical performance of HEco Series freezer with full inventory system and factory recommended level settings. Actual performance may vary with atmospheric conditions and usage.



MVE High Efficiency 800 -190°C Series

Available with the TEC 3000

The MVE High Efficiency 800 Freezer Series provides vapor storage temperature at -190°C. Available in two unique sizes these freezers provide optimized storage density and provide long hold times. The MVE High Efficiency 800 Series freezer is capable of storing over 1800 blood bags.

Key Features

- Dry sample storage
- -190°C top box temperature
- Low liftover height
- Large LN₂ capacity at vapor platform
- Optional Battery Backup



Rack Layout

Square Rack Layout (P)

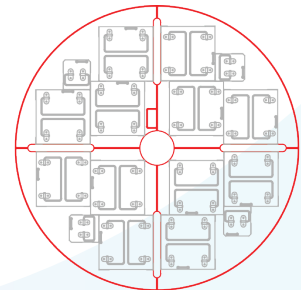

4R9951 Layout (R)

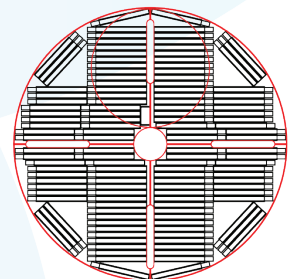

MVE High Efficiency 800 -190°C Series

	MVE 815P-190	MVE 819P-190				
Maximum Storage Capacities						
○ 1.2 & 2 ml Vials (Internally Threaded)	15,600	19,500				
○ Quantity of Large Racks 100 cell boxes	12	12				
○ Quantity of Mini Racks 25 cell boxes	4	4				
○ Number of Shelves per Rack	12	15				
Performance						
○ LN ₂ Capacity at Vapor Platform L est.	62	55				
○ LN ₂ Capacity w/o Inventory L est.	360	463				
Unit Dimensions						
○ Neck Opening in. (mm)	12.5 (317)	12.5 (317)				
○ Usable Internal Height in. (mm)	26.5 (673)	34.5 (877)				
○ Inner Diameter in. (mm)	28.8 (731)	28.8 (731)				
○ Overall Height w/Autofill in. (mm)	58.2 (1478)	65.0 (1651)				
○ Door Width Requirement** in. (mm)	32.0 (813)	32.0 (813)				
○ Door Width Requirement** with handles in. (mm)	33.2 (843)	33.2 (843)				
○ Weight Empty* lb. (kg)	480 (218)	515 (234)				
○ Weight Liquid Full* lb. (kg) est.	1160 (526)	1340 (608)				
Blood Bag Capacities						
	Total Bags	Bags/ Frame	No. Frames	Total Bags	Bags/ Frame	No. Frames
○ 791 OS/U Medsep (25 ml)	1,224	6	204	1,836	9	204
○ 4R9951 (50 ml)	768	6	128	1024	8	128
○ 4R9953 (250 ml)	416	4	104	520	5	104
○ 4R9955 (500 ml)	304	4	76	380	5	76
○ DF200 (200 ml)	236	4	59	295	5	59

FIVE Year Vacuum Warranty - TWO Year Parts Warranty

Conforms to MDD 93/42/EEC, the Medical Device Directive for the EU. Freezer systems UL/C-UL Listed.

* Without inventory

**Minimum width required for vessel to pass through opening. Footprint may vary. Contact Tech Service for detailed drawings.

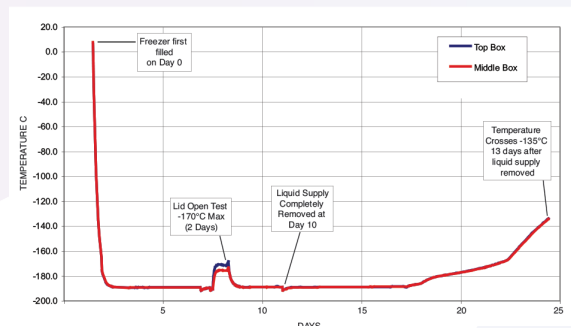

Temperature Test Graph

* Temp Test indicates typical performance of 800 Series -190°C freezer with full inventory system and factory recommended level settings. Actual performance may vary with atmospheric conditions and usage.

© 2024 MVE Biological Solutions reserves the right to discontinue its products, or change the prices, materials, equipment, quality, descriptions, specifications and/or processes to its products at any time without prior notice and with no further obligation or consequence. All rights not expressly stated herein are reserved by us, as applicable.





MVE High Efficiency 1500 -190°C Series

Available with the TEC 3000

The MVE 1500 Series -190°C freezers provide cryogenic storage for up to 42,000 1.2 / 2.0 ml vials. Available in three unique sizes, these freezers provide maximum storage density and provide long hold times. The MVE High Efficiency 1500 Series freezer is capable of storing over 3100 blood bags.

Key Features

- Dry sample storage
- -190°C top box temperature
- Low liftover height
- Large LN₂ capacity at vapor platform
- Optional Battery Backup



Rack Layout

Square Rack Layout (P)

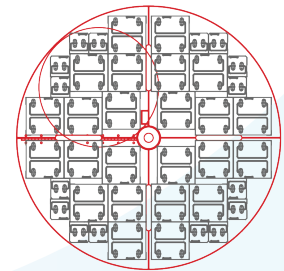

4R9951 Layout (R)

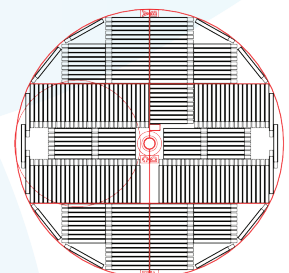

MVE High Efficiency 1500 -190°C Series

	MVE 1536P-190	MVE 1539P-190	MVE 1542R-190						
Maximum Storage Capacities									
○ 1.2 & 2 ml Vials (Internally Threaded)	36,400	39,200	42,000						
○ Quantity of Large Racks 100 cell boxes	24	24	26						
○ Quantity of Mini Racks 25 cell boxes	16	16	16						
○ Number of Shelves per Rack	13	14	14						
Performance									
○ LN ₂ Capacity at Vapor Platform L est.	133	133	133						
○ LN ₂ Capacity w/o Inventory L est.	756	797	797						
Unit Dimensions									
○ Neck Opening in. (mm)	17.5 (445)	17.5 (445)	17.5 (445)						
○ Usable Internal Height in. (mm)	28.8 (732)	30.8 (782)	30.8 (782)						
○ Inner Diameter in. (mm)	38.5 (978)	38.5 (978)	38.7 (983)						
○ Overall Height w/ AutoFill in. (mm)	61.3 (1556)	63.3 (1608)	63.3 (1608)						
○ Liftover Height in. (mm)	37.1 (942)	39.2 (995)	39.2 (995)						
○ Door Width Requirement** in. (mm)	42.0 (1067)	42.0 (1067)	42.0 (1067)						
○ Depth of Extended Step in. (mm)	7.9 (201)	7.9 (201)	7.9 (201)						
○ Weight Empty* lb. (kg)	690 (313)	720 (327)	720 (327)						
○ Weight Liquid Full* lb. (kg) est.	2037 (924)	2140 (971)	2140 (971)						
Blood Bag Capacities									
	Total Bags	Bags/ Frame	No. Frames	Total Bags	Bags/ Frame	No. Frames	Total Bags	Bags/ Frame	No. Frames
○ 791 OS/U Medsep (25 ml)	2,905	7	415	3,320	8†	415	3,184	8†	398
○ 4R9951 (50 ml)	1,488	6	248	1,736	7	248	1,687	7	241
○ 4R9953 (250 ml)	812	4	203	812	4	203	768	4	192
○ 4R9955 (500 ml)	608	4	152	608	4	152	576	4	144
○ DF200 (200 ml)	496	4	124	496	4	124	488	4	122
○ DF700 (700 ml)	256	4	64	256	4	64	264	4	66

FIVE Year Vacuum Warranty • TWO Year Parts Warranty

Conforms to MDD 93/42/EEC, the Medical Device Directive for the EU. Freezer systems UL/C-UL Listed.

* Without inventory

**Minimum width required for vessel to pass through opening. Footprint may vary. Contact Tech Service for detailed drawings.

† Between usable height and clearance. Please refer to specifications.

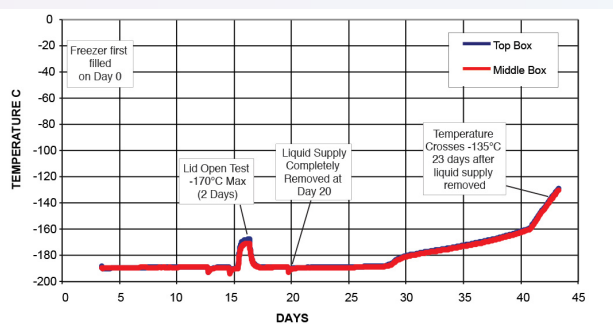

Temperature Test Graph

* Temp Test indicates typical performance of 1500 Series -190°C freezer with full inventory system and factory recommended level settings. Actual performance may vary with atmospheric conditions and usage.

© 2023 MVE Biological Solutions reserves the right to discontinue its products, or change the prices, materials, equipment, quality, descriptions, specifications and/or processes to its products at any time without prior notice and with no further obligation or consequence. All rights not expressly stated herein are reserved by us, as applicable.





MVE High Efficiency 1800 -190°C Series

Available with the TEC 3000

The MVE 1800 Series -190°C freezers provide cryogenic storage for up to 94,500 1.2 / 2.0 ml vials. These freezers provide maximum storage density and provide long hold times. The MVE High Efficiency 1800 Series freezer is capable of holding over 8,400 blood bags.

Key Features

- Dry sample storage
- -190°C top box temperature
- Low liftover height
- Large LN₂ capacity at vapor platform
- Two tier folding step
- Optional Battery Backup



Rack Layout

Square Rack Layout (P)

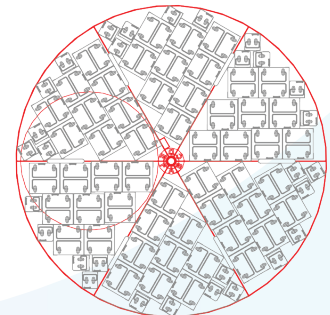

4R9951 Layout (R)

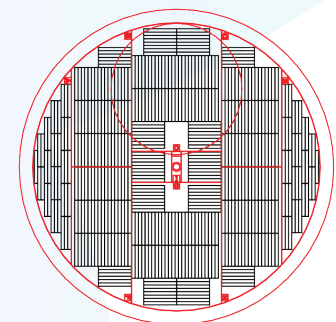

MVE High Efficiency 1800 -190°C Series

	MVE 1879P-190	MVE 1881R-190	MVE 1892P-190	MVE 1894R-190								
Maximum Storage Capacities												
○ 1.2 & 2 ml Vials (Internally Threaded)	79,950	81,900	92,250	94,500								
○ Quantity of Large Racks 100 cell boxes	54	60	54	60								
○ Quantity of Mini Racks 25 cell boxes	30	12	30	12								
○ Number of Shelves per Rack	13	13	15	15								
Performance												
○ LN ₂ Capacity at Platform Vapor L est.	290	305	282	300								
○ LN ₂ Capacity w/o Inventory L est.	1540	1521	1736	1731								
Unit Dimensions												
○ Neck Opening in. (mm)	25.0 (635)	25.0 (635)	25.0 (635)	25.0 (635)								
○ Usable Internal Height in. (mm)	29.5 (749)	29.2 (742)	34.5 (876)	34.2 (868)								
○ Inner Diameter in. (mm)	56.0 (1422)	54.8 (1391)	54.8 (1391)	54.8 (1391)								
○ Overall Height w/AutoFill in. (mm)	68.2 (1732)	68.2 (1732)	73.2 (1860)	73.2 (1860)								
○ Door Width Requirement** in. (mm)	60.0 (1524)	60.0 (1524)	60.0 (1524)	60.0 (1524)								
○ Weight Empty* lb. (kg)	1721 (781)	1721 (781)	1721 (781)	1721 (781)								
○ Weight Liquid Full* lb. (kg) est.	4830 (2191)	4830 (2191)	4875 (2211)	4875 (2211)								
Blood Bag Capacities												
	Total Bags	Bags/ Frame	No. Frames	Total Bags	Bags/ Frame	No. Frames	Total Bags	Bags/ Frame	No. Frames	Total Bags	Bags/ Frame	No. Frames
○ 791 OS/U Medsep (25 ml)	5,866	7	838	5,628	7	804	6,704	8	838	6,432	8	804
○ 4R9951 (50 ml)	2,952	6	492	2,940	6	490	3,936	8	492	3,920	8	490
○ 4R9953 (250 ml)	1,584	4	396	1,608	4	402	1,980	5	396	2,010	5	402
○ 4R9955 (500 ml)	1,104	4	276	1,240	4	310	1,380	5	276	1,550	5	310
○ DF200 (200 ml)	960	4	240	984	4	246	1,200	5	240	1,230	5	246
○ DF700 (700 ml)	504	4	126	544	4	136	630	5	126	680	5	136

FIVE Year Vacuum Warranty • TWO Year Parts Warranty

Conforms to MDD 93/42/EEC, the Medical Device Directive for the EU. Freezer systems UL/C-UL Listed.

* Without inventory

**Minimum width required for vessel to pass through opening. Footprint may vary. Contact Tech Service for detailed drawings.

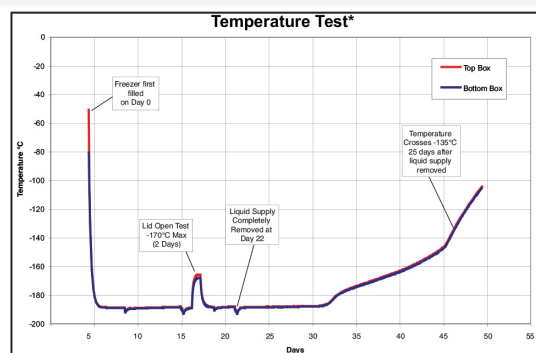

Temperature Test Graph

* Temp Test indicates typical performance of 1800 Series -190°C freezer with full inventory system and factory recommended level settings. Actual performance may vary with atmospheric conditions and usage.



MVE Variō™ Series

With MVE Touch Screen or Variō Pro Controller

The MVE Variō™ Series is the innovative and energy efficient alternative for ultra low temperature to cryogenic storage. With this innovative alternative to mechanical freezers, you're firmly in control. That's because both the MVE 1500 and 1800 Vario series models offer user-defined temperatures anywhere between -20°C and -150°C. And the available conversion kit allows you to operate the Vario as a high-efficiency -190C freezer.

Because the MVE Vario Series offers a completely dry sample storage area, you'll reduce the possibility of sample contamination via contact with LN₂. Compared to mechanical freezers, which allow heat to enter when opened, the MVE Vario Series offers a consistent temperature profile. Even when you open the lid or introduce warm samples to this cryogenic freezer, there's minimal temperature variability. This means you constantly protect innocent samples from transient warming events that may continue to heat them after the freezer is closed.

Key Features

- Approximately 70% operating cost savings compared to leading mechanical freezers (-80 °C)
- Less than 1% of the electricity consumption compared to leading mechanical freezers (-80 °C)
- Completely dry storage area
- Consistent temperature profile, even with lid open
- Improved processing time, minimal increase in temperature when warm samples introduced
- No thermal load; no heat introduced into room and no additional HVAC required
- No more expensive compressors to replace
- Convertible asset: can be retrofitted to expand temperature range to -190
- Available with a touch screen



Rack Layout

Square Rack Layout (P)

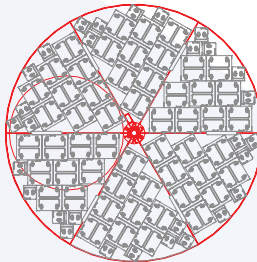

STANDARD
OPTIONAL

4R9951 Layout (R)

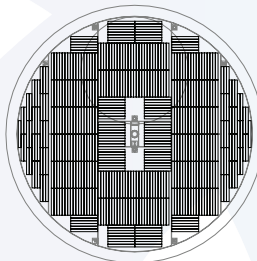

MVE Variō™ Series

	MVE Variō 1536P	MVE Variō 1539R	MVE Variō 1879P	MVE Variō 1881R	MVE Variō 1894R										
Maximum Storage Capacity															
○ 1.2 & 2 ml Vials (Internally Threaded)	36,400	39,000	79,950	81,900	94,500										
○ Quantity of Large Racks 100 cell boxes	24	26	54	60	60										
○ Quantity of Mini Racks 25 cell boxes	16	16	30	12	12										
○ Number of Shelves per Rack	13	13	13	13	15										
Performance															
○ Temperature Range	-20°C, -150°C	-20°C, -150°C	-20°C, -150°C	-20°C, -150°C	-20°C, -150°C										
○ Power consumption (cont.) W	8	8	8	8	8										
Unit Dimensions															
○ Neck Opening in. (mm)	17.5 (445)	17.5 (445)	25.0 (635)	25.0 (635)	25.0 (635)										
○ Usable Internal Height in. (mm)	28.8 (732)	29.3 (745)	29.5 (749)	29.2 (741)	34.2 (868)										
○ Inner Diameter in. (mm)	38.5 (978)	38.5 (978)	56.0 (1,422)	54.8 (1,391)	54.8 (1,391)										
○ Overall Height in. (mm)	61.3 (1,556)	61.3 (1,556)	62.1 (1,577)	61.3 (1,556)	66.3 (1,683)										
○ Door Width Requirement** in. (mm)	42.0 (1,067)	42.0 (1,067)	60.0 (1,524)	60.0 (1,524)	60.0 (1,524)										
○ Weight Empty* lb. (kg)	690 (313)	690 (313)	1,606 (728)	1,721 (781)	1,721 (781)										
Blood Bag Capacities															
	Total Bags	Bags/ Frame	No. Frames	Total Bags	Bags/ Frame	No. Frames	Total Bags	Bags/ Frame	No. Frames	Total Bags	Bags/ Frame	No. Frames	Total Bags	Bags/ Frame	No. Frames
○ 791 OS/U Medsep (25 ml)	3,080	7	440	2,786	7	398	5,866	7	838	5,628	7	804	6,432	8	804
○ 4R9951 (50 ml)	1,488	6	248	1,446	6	241	2,952	6	492	2,940	6	490	3,920	8	490
○ 4R9953 (250 ml)	812	4	203	768	4	192	1,584	4	396	1,608	4	402	2,010	5	402
○ 4R9955 (500 ml)	608	4	152	576	4	144	1,104	4	276	1,240	4	310	1,550	5	310
○ DF200 (200 ml)	496	4	154	488	4	122	960	4	240	984	4	246	1,230	5	246
○ DF700 (700 ml)	256	4	64	204	4	66	504	4	126	544	4	136	680	5	136

FIVE Year Vacuum Warranty • TWO Year Parts Warranty

Conforms to MDD 93/42/EEC, the Medical Device Directive for the EU. Freezer systems UL/C-UL Listed. (Only Freezers with the Variō Pro Controller)

* Without inventory

**Minimum width required for vessel to pass through opening. Footprint may vary. Contact Tech Service for detailed drawings.

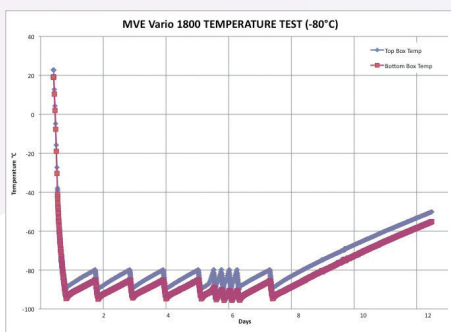

Temperature Test Graph

* Temp Test indicates typical performance of MVE Variō Series freezer with full inventory system and factory recommended level settings. Actual performance may vary with atmospheric conditions and usage.

© 2024 MVE Biological Solutions reserves the right to discontinue its products, or change the prices, materials, equipment, quality, descriptions, specifications and/or processes to its products at any time without prior notice and with no further obligation or consequence. All rights not expressly stated herein are reserved by us, as applicable.





MVE Series

Available with the TEC 3000

The MVE Series freezers provide stable cryogenic storage for up to 39,000 1.2 / 2.0 ml vials. These freezers provide maximum storage density and provide long hold times. MVE Series are primarily designed for liquid storage.

Key Features

- Liquid sample storage
- Wide neck opening
- Low liftover height
- Large LN₂ capacity
- Optional Battery Backup



MVE Series

	MVE 205	MVE 510	MVE 616	MVE 1426	MVE 1839
Maximum Storage Capacity					
○ 1.2 & 2 ml Vials (Internally Threaded)	5,200	10,400	16,900	26,650	39,000
○ Number of Racks 100 cell boxes	4	7	12	18	28
○ Number of Racks 25 cell boxes	-	4	4	10	8
○ Number of Stages per Rack	13	13	13	13	13
Performance					
○ LN ₂ Capacity L	95	166	240	388	673
Unit Dimensions					
○ Neck Opening in. (mm)	16.00 (406)	20.70 (527)	25.10 (638)	31.75 (806)	39.40 (1002)
○ Usable Internal Height in. (mm)	28.9 (735)	30.0 (762)	29.5 (749)	29.3 (745)	33.6 (854)
○ Inner Diameter in. (mm)	16.00 (406)	20.70 (527)	25.1 (638)	31.75 (806)	39.40 (1002)
○ Overall Height w/ AutoFill in. (mm)	46.3 (1176)	46.7 (1185)	45.8 (1161)	46.8 (1188)	54.0 (1372)
○ Door Width Requirement** in. (mm) Outer Dimensions	23.6x22.7 (601x577)	30.6x29.7 (778x754)	33.5x34.6 (852x878)	40x41.6 (1017x1056)	46.8x48.9 (1187x1242)
○ Weight Empty lb. (kg)	195 (88)	281 (127)	320 (145)	490 (222)	750 (341)
○ Weight Liquid Full* lb. (kg)	365 (166)	577 (262)	748 (339)	1181 (536)	1950 (885)

	MVE 205			MVE 510			MVE 616			MVE 1426			MVE 1839		
Blood Bag Capacities	Total Bags	Bags/ Frame	No. Frames	Total Bags	Bags/ Frame	No. Frames	Total Bags	Bags/ Frame	No. Frames	Total Bags	Bags/ Frame	No. Frames	Total Bags	Bags/ Frame	No. Frames
○ 791 OS/U Medsep (25 ml)	539	7	77	882	7	126	1,372	7	196	2,226	7	318	3,968	8	496
○ 4R9951 (50 ml)	228	6	38	420	6	70	612	6	102	924	6	154	1,856	8	232
○ 4R9953 (250 ml)	128	4	32	224	4	56	336	4	84	512	4	128	1,010	5	202
○ 4R9955 (500 ml)	96	4	24	160	4	40	248	4	62	424	4	106	770	5	154
○ DF200 (200 ml)	80	4	20	128	4	32	200	4	50	336	4	84	610	5	122
○ DF700 (700 ml)	40	4	10	68	4	17	116	4	29	168	4	42	380	5	76

FIVE Year Vacuum Warranty • TWO Year Parts Warranty

Conforms to MDD 93/42/EEC, the Medical Device Directive for the EU. Freezer systems UL/C-UL Listed.

* Without inventory

**Minimum width required for vessel to pass through opening. Footprint may vary. Contact Tech Service for detailed drawings.

***Not available with Auto Fill.

† Not available with Auto Fill. CE Marked but MDD does not apply.

Note: The usable height is decreased when using a vapor platform, and storage capacity is reduced when using a sleeve.



Rack Layouts

4R9953 Layout

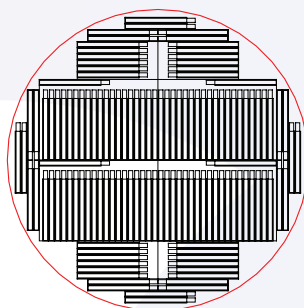

DF700 Layout

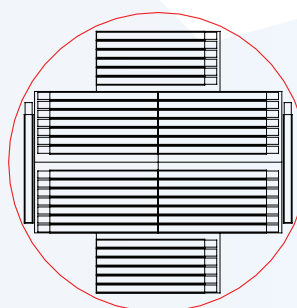



MVE 816P-2T-190

Available with the TEC 3000

The MVE 816P-2T-190 freezer is designed with the fertility market in mind. With its unique two-tier tray design, it can hold vials, straws and SUC-1 canisters which are used by leading fertility clinics worldwide. A constant temperature allows for vapor storage throughout the freezer at near liquid nitrogen temperatures. The innovative inventory system incorporates a two level storage arrangement that utilizes an access portal to allow removal of product stored on the lower level.

Key Features

- Vapor phase storage temperature of -190°C*
- Two tier storage system maximizes capacity while minimizing floor space
- High efficiency design with offset neck for lowest possible LN₂ consumption
- Optional Battery Backup
- TEC 3000 control system with liquid level control and temperature alarms
- Optional one-or two-tier step

Innovative Storage System

Two tier storage (with cutout in top tier) allows convenient access to bottom tier.

Temperature Test Graph

Temp Test indicates typical performance of 816P-2T -190°C freezer with full inventory system and factory recommended level settings. Actual performance may vary with atmospheric conditions and usage.

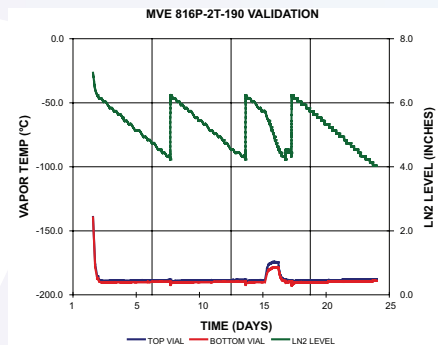

MVE 816P-2T-190

Maximum Storage Capacity	
○ 1.2 & 2 ml Vials (Internally Threaded)	10,500
○ Quantity of Large Racks 100 cell boxes	-
○ Quantity of Mini Racks 25 cell boxes	-
○ Number of Shelves per Rack	-
○ High Security Straw Capacity (0.5 ml)	31,584
○ Number of Canisters (73 mm)	94
○ Goblets/Canister : Straws/Goblet	2:168
○ Number of SUC-1 Canisters (2.5"x2.5"x11)	115
○ Number of 1.2 ml Vials on Canes	16,560
○ Number of 2.0 ml Vials on Canes	9,200
○ Number of 1/2 cc Straws 10/cane	35,650
Performance	
○ LN ₂ Capacity at Platform Vapor L est.	56
○ LN ₂ Capacity w/o Inventory L est.	381
Unit Dimensions	
○ Neck Opening in. (mm)	12.5 (317)
○ Usable Internal Height in. (mm)	13.0 (330) per level
○ Inner Dimensions in. (mm)	28.70 (728) top tier 27.70 (702) bottom tier
○ Outer Dimensions in. (mm)	32 (813mm) 33.2 (843mm) w/ handles
○ Overall Height with Auto Fill in. (mm)	58.0 (1473)
○ Door Width Requirement** in. (mm) Outer Dims	32 (813)
○ Weight Empty* lb. (kg)	475 (215)
○ Weight Liquid Full* lb. (kg) est.	1155 (524)

FIVE Year Vacuum Warranty • TWO Year Parts Warranty

Conforms to MDD 93/42/EEC, the Medical Device Directive for the EU Freezer systems. UL/C-UL Listed.

* Without inventory

**Minimum width required for vessel to pass through opening. Footprint may vary. Contact Tech Service for detailed drawings.

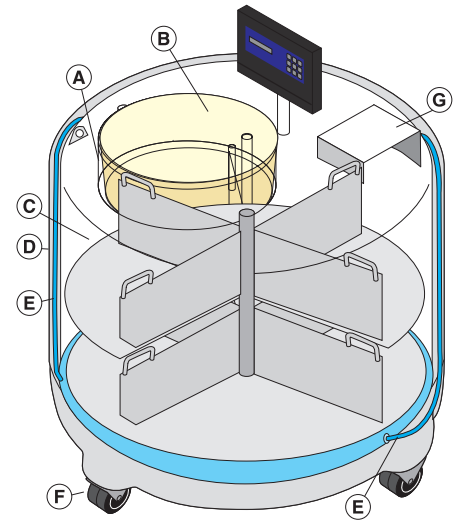

- A** Offset neck design minimizes liquid nitrogen consumption
- B** Lightweight composite lid is scratch and dent resistant
- C** Two level rotating tray provides easy access to samples
- D** Stainless steel construction reduces maintenance
- E** Annular (internal) filling lines minimizes frost build up and reduces maintenance requirements
- F** Durable casters equipped with brakes
- G** Lid Stand

Rack Layout

115 SUC Boxes Total

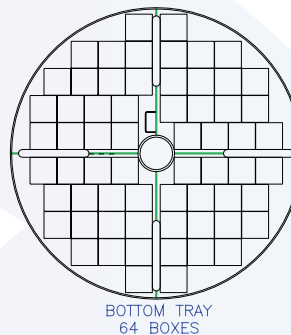
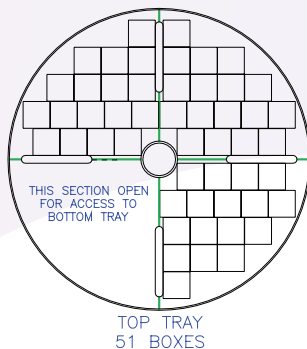



MVE Stock Series

Available with the TEC 3000

The MVE Stock Series provides high security for the IVF industry and are primarily used to store semen and embryos. The freezers are designed for easy sample access with a wide neck opening. Although engineered for liquid storage, most MVE Stock Series can be used to store in vapor.

Key Features

- Low liftover height
- Large LN₂ Capacity
- Optional Battery Backup



MVE Stock Series

	MVE 103***	MVE 816P-2T-190	MVE 1842P-150	MVE 1877P-2T-150
Maximum Storage Capacity				
○ 1.2 & 2 ml Vials (Internally Threaded)	-	10,500	-	-
○ Quantity of Large Racks 100 cell boxes	-	-	-	-
○ Quantity of Mini Racks 25 cell boxes	-	-	-	-
○ Number of Shelves per Rack	-	-	-	-
○ High Security Straw Capacity (0.5 ml)	7,728	31,584	-	347,424
○ Number of Canisters (73 mm)	23	94	-	517
○ Goblets/Canister : Straws/Goblet	2:168	2:168	2:168	4:168
○ Number of SUC-1 Canisters (2.5"x2.5"x11)	22	115	294	539
○ Number of 1.2 ml Vials on Canes	3,168	16,560	42,336	77,616
○ Number of 2.0 ml Vials on Canes	1,760	9,200	23,520	43,120
○ Number of 1/2 cc Straws 10/cane	6,820	35,650	91,140	167,090
Performance				
○ LN ₂ Capacity at Platform Vapor L est.	-	56	-	250
○ LN ₂ Capacity w/o Inventory L est.	39	381	872	1456
Unit Dimensions				
○ Neck Opening in. (mm)	16.0 (406)	12.5 (317)	25.0 (635)	25.0 (635)
○ Usable Internal Height in. (mm)	12.0 (305)	13.0 (330) per level	13.0 (330)	13.0 (330) per tray
○ Inner Diameter in. (mm)	16.00 (406)	28.70 (728) top tier 27.70 (702) bottom tier	56.1 (1425)	56.25 (1429) top and bottom tiers
○ Overall Height with Auto Fill in. (mm)	16.4 (415)***	58.0 (1473)	51.1 (1296)	64.6 (1639)
○ Door Width Requirement** in. (mm) Outer Dims	18 (457)	32 (813)	60 (1524)	60 (1524)
○ Weight Empty* lb. (kg)	48 (22)	475 (215)	1167 (530)	1721 (781)
○ Weight Liquid Full* lb. (kg) est.	117 (53)	1155 (524)	2721 (1234)	4316 (1958)

FIVE Year Vacuum Warranty • TWO Year Parts Warranty

Conforms to MDD 93/42/EEC, the Medical Device Directive for the EU. Freezer systems UL/C-UL Listed.

MVE 103 is CE Marked but MDD does not apply.

* Without inventory

**Minimum width required for vessel to pass through opening. Footprint may vary. Contact Tech Service for detailed drawings.

***Not available with Auto Fill.



© 2024 MVE Biological Solutions reserves the right to discontinue its products, or change the prices, materials, equipment, quality, descriptions, specifications and/or processes to its products at any time without prior notice and with no further obligation or consequence. All rights not expressly stated herein are reserved by us, as applicable.



MVE CryoCart

Biological sample loading

MVE CryoCarts are designed for the loading of biological samples into canes, boxes, racks or frames. When used as a portable cryogenic workbench, the unit will provide a safe and controlled environment for your samples for up to eight hours with the lid open. MVE CryoCart is ideal for transporting large quantities of samples from one tank to another within the same facility.

Key Features

- Approximate hold time of 18 hours with lid on
- Temperature monitor with type T Thermocouple
- Traceable calibration certificate with RS232 PC interface
- LN₂ transfer hose connection with ball valve and relief valve



MVE CryoCart

Performance

○ LN₂ Capacity w/o Inventory To Top of Platform L est. 39.5

Unit Dimensions

○ Overall Length in (mm) 54.46 (1383)

○ Overall Width in (mm) 20.16 (512)

○ Overall Height in (mm) 39.5 (1003)

○ Lift Overall Height in (mm) 37.2 (944)

○ Inside Length in (mm) 41.0 (1041)

○ Inside Width in (mm) 13.2 (335)

○ Inside Depth in (mm) 15.4 (391)

○ Platform Height in (mm) 4.5 (114)

○ Footprint in (mm) 17.6 x 51.7 (447 x 1313)

○ Weight Empty lb. (kg) 195 (88)

○ Weight w/LN₂ Filled to Top of Platform lb. (kg) est. 266 (121)

○ Number of Racks (15-2) 2

ONE Year Vacuum Warranty • 90 Days Parts Warranty.
Not designed for long-term storage.



MVE Research Dewars

Small thermal dewar for temporary storage

The MVE Research Dewars are developed specifically for easy and safe handling of liquid nitrogen and samples within facilities. These units are vacuum insulated for temporary storage of samples within facilities.

Key Features

- All stainless steel construction
- Optional insulated lid (cork & cover is not included)
- Wide mouth for easy access
- Convenient carrying handle (except .5L)
- Meets laboratory safety requirements

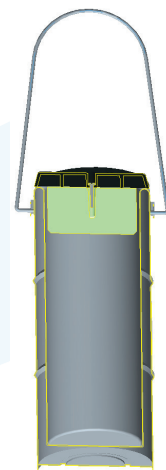

MVE Research Dewars

	RD-6	RD-3	RD-2	RD-1	RD-1W	RD-0.5
Performance						
○ LN ₂ Capacity L est.	6	3	2	1	1	0.5
○ Handle	yes	yes	yes	yes	yes	no
Unit Dimensions						
○ Neck Opening in. (mm)	7.3 (185)	7.3 (185)	3.9 (99)	3.3 (84)	3.9 (99)	2.6 (66)
○ Inner Diameter in. (mm)	7.3 (185)	7.3 (185)	3.9 (99)	3.3 (84)	3.9 (99)	2.6 (66)
○ Outside Diameter in. (mm)	7.8 (198)	7.8 (198)	4.8 (122)	4.3 (109)	4.8 (122)	3.4 (86)
○ Usable Internal Height in. (mm)	10.6 (269)	6.3 (160)	7.1 (180)	6.2 (157)	6.1 (155)	7.1 (180)
○ Overall Height in. (mm)	11.8 (300)	7.5 (191)	12.3 (312)	9.1 (231)	7.0 (178)	8.0 (203)
○ Weight Empty* lb. (kg)	4.4 (2.0)	3.3 (1.5)	1.8 (0.8)	1.1 (0.5)	1.1 (0.5)	0.7 (0.3)
○ Weight Liquid Full* lb. (kg)	15.0 (6.8)	8.6 (3.9)	5.3 (2.4)	2.9 (1.3)	2.9 (1.3)	1.5 (0.7)
○ NER without Cover L/Hr	0.4	0.2	0.1	0.1	0.2	0.1

90-Day Warranty

*Estimated weights

Research dewars are not designed for short or long term sample storage.



MVE CryoSystem 6000 Full Auto

With the TEC 3000

The MVE CryoSystem 6000 Full Auto combines the compact efficiency of aluminum dewars with the monitoring and auto fill features of the TEC3000 control system. The TEC3000 continually monitors and records temperature and LN₂ levels, auto filling when needed, and providing audio/visual alarms with remote connectivity when necessary. The enhanced safety factor of not having to manually fill this unit also helps maintain a consistent temperature profile.

The CryoSystem 6000 Full Auto provides the convenience and security of high capacity stainless steel freezers for your average sized sample collection at a fraction of the price.

Key Features

- Fully automatic LN₂ level control and temperature monitoring
- Designed for liquid storage.
- 17 user-defined audio / visual alarms
- Newly designed, durable lid
- Controller post tilted for convenient LCD viewing
- Easily moved in case of emergencies or in the event of natural disasters
- Includes six racks, transfer hose, and roller base



MVE CryoSystem 6000 Full Auto

Performance

○ LN ₂ Capacity w/o Inventory L est.	175.0
○ Static Evaporation Rate* L/day	2.5

Unit Dimensions

○ Neck Opening in. (mm)	8.5 (216)
○ Overall Height with Auto Fill in. (mm)	37.9 (963)
○ Outer Diameter in. (mm)	26.5 (673)
○ Weight Empty lb. (kg)	156 (70.7)
○ Weight Full lb. (kg) est.	478 (216.8)

Maximum Storage Capacity

○ Box Size in. Standard box side is 2 inches. Additional sizes available.	2	3	3.75
○ Number of Racks	6	6	6
○ Number of vials 1.2 & 2 ml vials 100/box est.	6,000	4,200	3,000
○ Boxes per Rack	10	7	5

* Static evaporation rate and static holding time are nominal. Actual rate and holding time will be affected by the nature of container use, atmospheric conditions, and manufacturing tolerances.

THREE Year Vacuum Warranty • TWO Year Parts Warranty

Conforms to MDD 93/42/EEC, the Medical Device Directive for the EU.

Tank Features

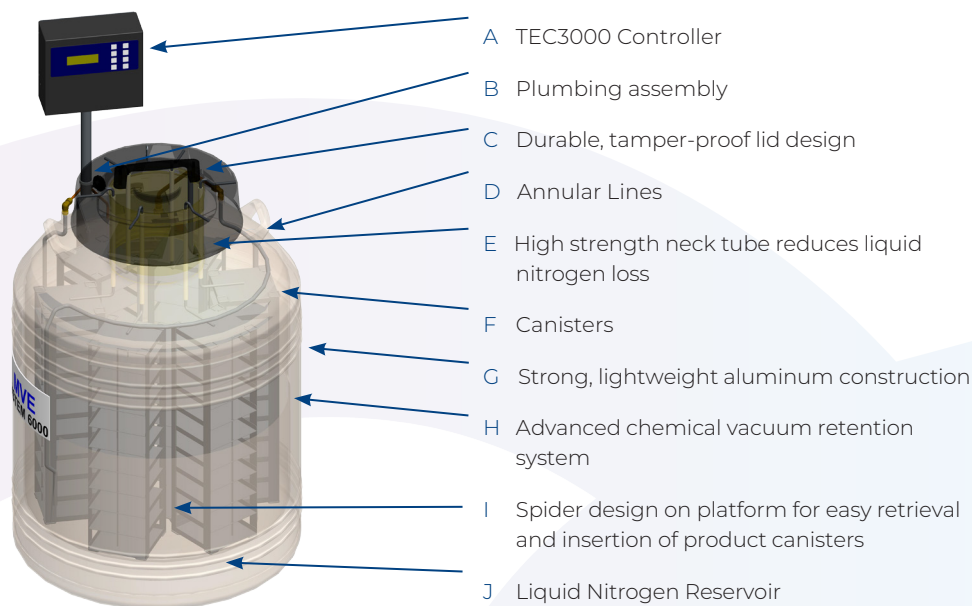

MVE CryoSystem Series

Low nitrogen consumption dewar

The MVE CryoSystem Series combines the benefits of low nitrogen consumption with mid-range vial capacity to meet the diverse needs of today's professionals worldwide. The lightweight and low-space demands of these containers make them one of the most economical units in their class.

Key Features

- Designed for medium vial storage capacity
- Low liquid nitrogen consumption
- Optional rollerbase system for easy moveability



MVE CryoSystem Series

	Cryosystem 750	Cryosystem 2000	Cryosystem 4000	Cryosystem 6000
Maximum Storage Capacity				
○ Number of Canisters	6	4	4	6
○ Number of 1.2 & 2.0 ml vials 100/box	-	2,000	4,000	6,000
○ Number of 1.2 & 2.0 ml vials 25/box	750	-	-	-
○ Boxes per Rack	5	5	10	10
Performance				
○ LN ₂ Capacity w/o Inventory L est.	47	61	121	175
○ LN ₂ Capacity w/Inventory L est.	45	51	111	150
○ Static Evaporation Rate* L/day	0.39	0.85	0.99	0.99
○ Working Duration** Full Days	76	38	66	104
Unit Dimensions				
○ Neck Opening in. (mm)	5.0 (127)	8.5 (216)	8.5 (216)	8.5 (216)
○ Overall Height in. (mm)	26.50 (673)	27.25 (692)	38.00 (965)	37.9 (963)
○ Outer Diameter in. (mm)	20 (508)	22 (559)	22 (559)	26.5 (673)
○ Weight Empty lb. (kg)	42 (19.0)	58 (26.3)	81 (36.7)	103 (46.7)
○ Weight Full lb. (kg)	126 (57)	182 (82.5)	300 (136)	425 (193)

* Static evaporation rate and static holding time are nominal. Actual rate and holding time will be affected by the nature of container use, atmospheric conditions, and manufacturing tolerances.

** Working Duration is an arbitrary reference, to estimate container performance under normal operating conditions in liquid storage. Actual working time may vary due to current atmospheric conditions, container history, manufacturing tolerances and patterns of use.

THREE Year Vacuum Warranty • TWO Year Parts Warranty

Conforms to MDD 93/42/EEC, the Medical Device Directive for the EU.

Tank Features

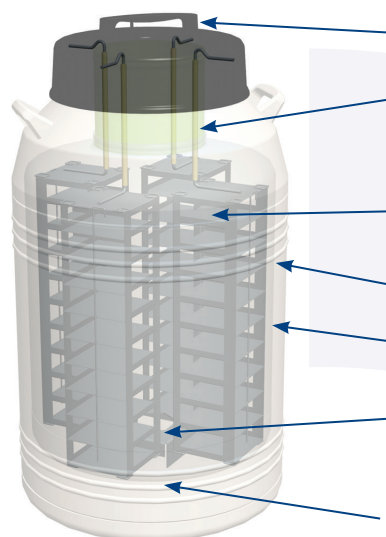

- A** Durable, tamper-proof lid design
- B** High strength neck tube reduces liquid nitrogen loss
- C** Racks
- D** Strong, lightweight aluminum construction
- E** Advanced chemical vacuum retention system
- F** Spider design on platform for easy retrieval and insertion of product canisters
- G** Liquid Nitrogen Reservoir

MVE Lab Series

Cryogenic liquid dewars

The Lab Series cryogenic liquid dewars are named for their acceptance in laboratories and medical facilities worldwide. These high-efficiency, super insulated dewars are the most convenient, economical way to store and dispense liquid nitrogen. Many lab units can be fitted with pouring spouts, pressurized dispensing devices or dippers to aid in the transfer of liquid nitrogen.

Key Features

- Designed for efficient storage of liquid nitrogen
- Low liquid nitrogen consumption
- Convenient lightweight package



MVE Lab Series

	LAB 4	LAB 5	LAB 10	LAB 20	LAB 30	LAB 50
Performance						
○ LN ₂ Capacity L	4	5	10	20	32	50
○ Static Evaporation Rate* L/day	0.19	0.15	0.18	0.18	0.22	0.49
Unit Dimensions						
○ Neck Opening in. (mm)	1.40 (35)	2.18 (56)	2.18 (56)	2.18 (56)	2.50 (64)	2.50 (64)
○ Useable Height in. (mm)	7.8 (198)	10.5 (266)	13.5 (343)	13.7 (348)	14.9 (378)	22.0 (559)
○ Overall Height in. (mm)	16.8 (426)	18.2 (462)	21.5 (546)	24.5 (622)	24.0 (610)	30.5 (775)
○ Outer Diameter in. (mm)	7.3 (185)	8.8 (222)	10.3 (260)	14.5 (368)	17.0 (432)	17.0 (432)
○ Internal Diameter in. (mm)	5.5 (139)	6.5 (165)	8.3 (210)	11.4 (289)	14.0 (356)	14.0 (356)
○ Weight Empty lb. (kg)	6 (2.7)	8 (4)	12 (5.4)	19 (9)	25 (11.4)	31 (14)
○ Weight Full lb. (kg)	13 (6)	17 (8)	31 (14)	55 (25)	82 (37.2)	120 (54.4)

FIVE Year Vacuum Warranty • TWO Year Parts Warranty

* Static evaporation rate and static holding time are nominal. Actual rate and holding time will be affected by the nature of container use, atmospheric conditions, and manufacturing tolerances.

Note: The Lab Series is designed for liquid storage.

Tank Features



- A** Durable composite lid design
- B** High strength neck tube reduces liquid nitrogen loss
- C** Strong, lightweight aluminum construction
- D** Advanced chemical vacuum retention system
- E** Liquid Nitrogen Reservoir



MVE SC Series

Compact Aluminum Dewar

The SC Series of tanks offers standard inventory capacity with capacity across the tanks with increasing hold times depending on the capacity. Each tank is equipped with the 2.18in (55mm) neck opening setting the standard for the canister size and inventory capacity. The SC 20/20 Signature builds on the industry gold standard tank for years now revolutionizing into the world most efficient cryogenic dewar fitted with Bend Don't Break durability technology.

Key Features

- Designed for industry standard capacity storage
- Low liquid nitrogen consumption
- Convenient lightweight package
- SC 20/20 Signature includes Bend Don't Break™ durability feature



MVE SC Series

	SC 3/3	SC 11/7	SC 20/20 Signature
Maximum Storage Capacity			
○ Number of Canisters	6	6	6
○ Number of 1/2 cc straws 10/cane	-	660	660
○ Number of 1/2 cc straws 1 Level Bulk	440	879	879
○ Number of 1/4 cc straws	-	210	210
Performance			
○ LN ₂ Capacity L	3.6	11.0	20.5
○ Static Evaporation Rate L/day*	0.13	0.16	0.085
○ Static Holding Time days	17	43	150
Unit Dimensions			
○ Neck Opening in. (mm)	2.18 (55)	2.18 (55)	2.16 (55)
○ Overall Height in. (mm)	16.0 (406)	21.6 (549)	26.0 (660)
○ Outer Diameter in. (mm)	8.7 (222)	10.2 (260)	14.5 (368)
○ Canister Height in. (mm)	5.0 (127)	11.0 (279)	11.0 (279)
○ Canister Diameter in. (mm)	1.65 (41.9)	1.65 (41.9)	1.65 (41.9)
○ Weight Empty lb. (kg)	8 (3.6)	17 (7.7)	22.5 (10.2)
○ Weight Full lb. (kg)	14.4 (6.5)	36.6 (16.6)	58.99 (26.7)

FIVE Year Vacuum Warranty • TWO Year Parts Warranty

* Static evaporation rate and static holding time are nominal. Actual rate and holding time will be affected by the nature of container use, atmospheric conditions, and manufacturing tolerances.

Conforms to MDD 93/42/EEC, the Medical Device Directive for the EU.

Tank Features

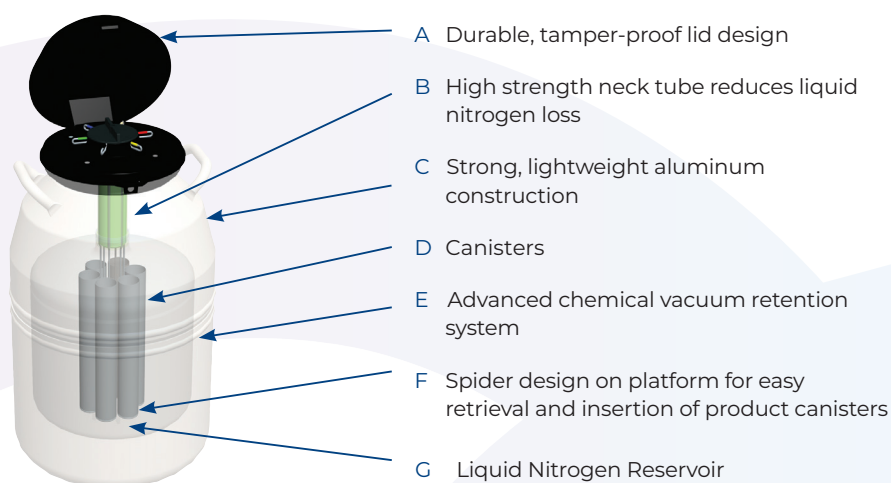



MVE XC Series

Large capacity storage

MVE XC Series tanks have capacities ranging from 700–5000 straws and 210 to over 1000 vials. Manufactured to a world-class level of excellence and backed by an industry-leading 5-year vacuum warranty, these durable, lightweight units can be relied on to perform in the most demanding of environments. The XC Series offers a range of capacity depending on on the user needs. Neck size and canister dimensions vary from model to model in order to optimize the sample capacity, inventory system, or holding time for each application.

Key Features

- Designed for large-capacity storage
- Low liquid nitrogen consumption
- Convenient lightweight package
- XC 20 Signature includes Bend Don't Break™ & Semen Safe™ durability features



MVE XC Series

	XC 20 Signature	XC 32/8	XC 33/22	XC 34/18	XC 47/11-6SQ	XC 47/11-6	XC 47/11-10
Maximum Storage Capacity							
○ Number of Canisters	6	9	6	6	6 sq.	6	10
○ Number of 1/2 cc Straws 10/cane	660	2,520	1,260	2,100	-	4,500+	3,500
○ Number of 1/2 cc Straws 1 Level Bulk	879	3,960	1,764	3,000	-	6,216	5,000
○ Number of 1/2 cc Straws 2 Level Bulk	1,680	-	-	630	-	1,320	1,050
○ Number of 1.2 & 2.0 ml Vials 5/cane	210	855	360	-	750	-	-
Performance							
○ LN ₂ Capacity L	20.5	32.0	33.4	34.8	47.4	47.4	47.4
○ Static Evaporation Rate* L/day	0.090	0.35	0.14	0.18	0.39	0.39	0.39
○ Normal Working Duration**, Full Days	142	57	154	123	76	76	76
Unit Dimensions							
○ Neck Opening in. (mm)	2.18 (55.4)	3.81 (97)	2.75 (70)	3.50 (89)	5.00 (127)	5.00 (127)	5.00 (127)
○ Overall Height in. (mm)	26.0 (660)	21.5 (546)	26.0 (660)	26.6 (675)	26.5 (673)	26.5 (673)	26.5 (673)
○ Overall Inner Height in. (mm)	-	-	-	-	-	-	-
○ Outer Diameter in. (mm)	14.5 (368)	18.2 (464)	18.2 (464)	18.2 (464)	20.0 (508)	20.0 (508)	20.0 (508)
○ Canister Height in. (mm)	11/5 (279/127)	11 (279)	111 (279)	11 (279)	-	11 (279)	11 (279)
○ Canister Diameter in. (mm)	1.65 (41.9)	2.62 (67)	2.22 (56)	2.81 (71)	-	4.00 (102)	2.81 (71)
○ Weight Empty lb. (kg)	22 (10)	30 (13.6)	34 (15.4)	34 (15.4)	42 (19.0)	42 (19.0)	42 (19.0)
○ Weight Full lb. (kg)	58.4(26.5)	87.0 (39.5)	94.0 (42.5)	96.0 (43.5)	120.4 (54.6)	120.4 (54.6)	120.4 (54.6)

FIVE Year Vacuum Warranty • TWO Year Parts Warranty

* Static evaporation rate and static holding time are nominal. Actual rate and holding time will be affected by the nature of container use, atmospheric conditions, and manufacturing tolerances.

** Working Duration is an arbitrary reference, to estimate container performance under normal operating conditions in liquid storage. Actual working time may vary due to current atmospheric conditions, container history, manufacturing tolerances and patterns of use.

Conforms to MDD 93/42/EEC, the Medical Device Directive for the EU.

Tank Features

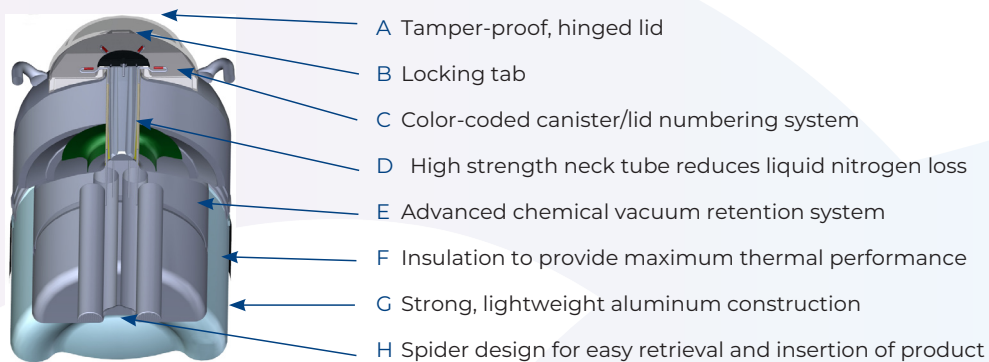

MVE Doble Series

With Advanced QWick™ Charge Technology

The Doble Series cryogenic liquid dewars are the first units to be designed for both vapor shipment and liquid storage. The Doble QWick Series utilizes an absorbent wicking material that charges with liquid nitrogen in two hours. *New/warm tanks still need to be filled with LN₂ and allowed to sit 24 hours to achieve maximum hold time. When a tank is already cold, the Advanced QWick Charge technology will apply, providing the capacity for same-day vapor shipping. A unique absorbent layer in the base of the storage tanks enables them to be charged with nitrogen and employed as dry shippers with hold times of up to 21 days. Once at the final destination, the tanks can be filled with liquid and used for long term storage, therefore avoiding the need for return shipments.

Key Features

- MVE Protective Shipping Containers are recommended
- Protective shipping containers ensure upright shipping
- Liquid and vapor storage options
- Low liquid nitrogen consumption
- Convenient lightweight package
- Charges in two hours*



MVE Doble Series

	Doble 11	Doble 20	Doble 22	Doble 28	Doble 34	Doble 47-6	Doble 47-10
Maximum Storage Capacity							
○ Number of Canisters	6	6	6	6	6	6	10
○ No. of 1/2 cc Straws 10/cane	660	660	2400	2,400	2,100	4,500	3,500
○ Vial Capacity	210	210	810	810	630	1,320	1,050
Performance (Hold Time overrides NER specifications)							
○ LN ₂ Capacity w/o Inventory L est.	10.0	18.5	20.0	28.0	32.0	46.0	46.0
○ Vapor Capacity L	3.1	4.2	5.5	8.4	7.9	6.0	6.0
○ Static Evaporation Rate L/day	0.17	0.10	0.35	0.35	0.20	0.40	0.40
○ Working Duration days for liquid	37	116	40	50	110	74	72
○ Working Duration days for vapor	17	21	18	21	21	21	21
Unit Dimensions							
○ Neck Opening in (mm)	2.18 (55)	2.18 (55)	3.81 (97)	3.81 (97)	3.50 (89)	5.00 (127)	5.00 (127)
○ Overall Height in (mm)	21.6 (549)	25.5 (647)	22 (559)	22 (559)	26.6 (676)	26.5 (673)	26.5 (673)
○ Outside Diameter in (mm)	10.2 (260)	14.5 (368)	14.5 (368)	18.2 (462)	18.2 (462)	20.0 (508)	20.0 (508)
○ Canister Height in (mm)	11 (279)	11 (279)	11 (279)	11 (279)	11 (279)	11 (279)	11 (279)
○ Canister Diameter in (mm)	1.65 (42)	1.65 (42)	3.09 (79)	3.09 (79)	2.81 (72)	4.00 (101)	2.81 (72)
○ Weight Empty lb. (kg)	14.5 (6.6)	23 (10.4)	23.8 (10.7)	33 (15.0)	34.5 (15.6)	41 (18.5)	41 (18.5)
○ Weight Charged vapor lb. (kg)	19.5 (8.8)	30.3 (13.7)	35 (15.8)	47 (21.3)	47.9 (21.7)	54.6 (24.7)	54.6 (24.7)
○ Weight Full liquid lb. (kg)	32 (14.5)	56 (25.4)	68 (30.8)	89 (40.4)	92 (41.7)	117 (53.1)	117 (53.1)
○ Protective Shipping Container Part No.	20750519	11912460	20750520	11930861	20863878	14035731	14035731

THREE Year Vacuum Warranty • TWO Year Parts Warranty

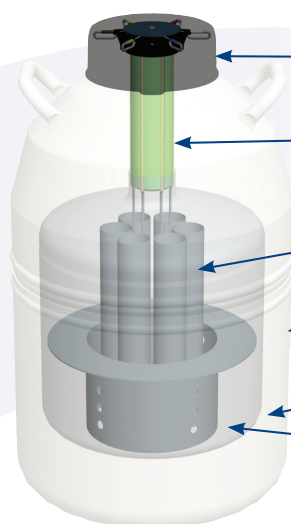

Tank Features

- A** Durable composite lid design
- B** High strength neck tube reduces liquid nitrogen loss
- C** Canisters
- D** Strong, lightweight aluminum construction
- E** Advanced chemical vacuum retention system
- F** Hydrophobic liquid nitrogen absorbent system



MVE CryoCube™ & BL-7

One-way cryogenic shipping

The MVE CryoCube and MVE BL-7 (Biologicistic) are secure one-way cryogenic shipping options for your biological samples. Both units incorporate creative engineering and simplistic design to allow shipping in any orientation without sacrificing temperature or hold time. Improved welded construction provides the MVE CryoCube and MVE BL-7 with consistent, high quality design with every unit. The units allow you to spend more time managing samples instead of managing shippers.

Key Features

- Charges in 2 hours*
Full charge - 24 hours*
Quick charge - 2 hours*
- Operates as a dry shipper
- -150° C temperature
- 7-day (BL-7) or 5-day (CryoCube) holding time
- Safe shipping in any orientation
- Safe for international shipping
- Welded construction for added integrity



CryoCube Insert

MVE CryoCube™ & BL-7

	MVE CryoCube™	MVE BL-7
Maximum Storage Capacity		
○ Number of Canisters	1	1
○ Number of 1/2 cc Straws 1 Level Bulk	182	270
Performance		
○ LN ₂ Capacity w/o Inventory L est.	1.5	2.1
○ Static Holding Time* days	5	7
Unit Dimensions		
○ Neck Opening in. (mm)	1.4 (35)	1.97 (50)
○ Overall Height in. (mm)	12.5 (317.5)	15.0 (381)
○ Overall Width in. (mm)	12 (305)	12.64 (321)
○ Overall Diameter in. (mm)	1.25 (32)	1.50 (38)
○ Weight Empty lb. (kg)	7.5 (3.41)	9.26 (4.2)
○ Weight Charged vapor lb. (kg)	10.2 (4.63)	13.01 (5.9)

ONE Year Vacuum Warranty

*Static evaporation rate and static holding time are nominal. Actual rate and holding time will be affected by the nature of container use, atmospheric conditions, and manufacturing tolerances.

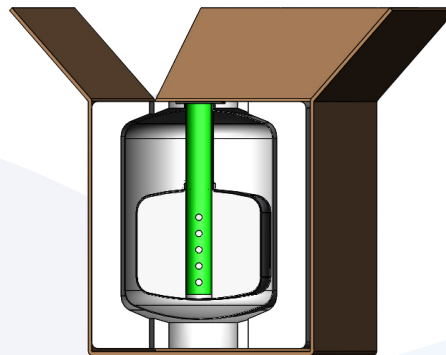
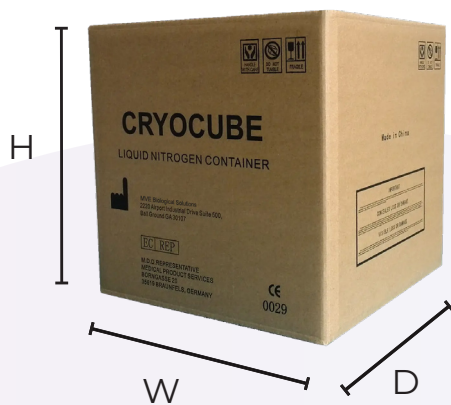



MVE Blood Bag Shippers CT-50 & CT-250

Reduce shipping costs for patient-specific therapies

MVE's secure specialty shippers fill unique biological sample cryogenic shipping and storage needs. The MVE CryoShipper CT-50 and CT-250 are designed to ship specific blood bags sizes. Our unique rack designs hold one to two blood bags to help limit sample movement during transit. The new design can also store samples in liquid nitrogen after arrival at the destination.

Key Features

- Safe for international shipping; IATA Dangerous Goods Regulations Exempt

(Special Provision A152)
- CryoShipper CT-50 and CT-250 charge in 2 hours*



MVE CryShipper CT-50 & CT-250

	CT-50**	CT-250**
Maximum Storage Capacity	17.6 (447)	
○ Number of Blood Bags	2 (25 mL)	2 (250 mL)
Performance		
○ LN ₂ Capacity w/o Inventory L est.	5	8
○ Static Evaporation Rate* L/day	0.5	0.8
○ Static Holding Time* days	10	10
Unit Dimensions		
○ Neck Opening in. (mm)	3.82 (97)	6.5 (165)
○ Overall Height in. (mm)	15 (380)	19.8 (502)
○ Outer Diameter/Width in. (mm)	14.5 (368)	16.0 (406)
○ Weight Empty lb. (kg)	17.6 (8)	24.3 (11)
○ Weight Charged vapor lb. (kg)	26.45 (12)	38.6 (17.5)

TWO Year Vacuum Warranty

* Static evaporation rate and static holding time are nominal. Actual rate and holding time will be affected by the nature of container use, atmospheric conditions, and manufacturing tolerances.

** CT = Cell Therapy

Conforms to MDD 93/42/EEC, the Medical Device Directive for the EU.





MVE Vapor Shipper Series

With Advanced QWick™ Charge Technology

The MVE Vapor Shipper Series is designed for the safe transportation of biological samples at cryogenic (-150°C or colder) temperatures. MVE Vapor Shipper Series utilizes the Advanced QWick Charge Technology that will charge the vapor shipper in two hours. *New/warm tanks still need to be filled with LN₂ and allowed to sit for 24 hours to achieve maximum hold time. When a tank is already cold, the Advanced QWick Charge technology will apply, providing the benefit of same-day vapor shipping. Manufactured from durable, lightweight aluminum, the vapor shippers employ a hydrophobic compound which absorbs the liquid nitrogen to ensure dry, spill-free vapor- phase shipping. MVE Protective Shipping Containers are recommended for usage. These containers may be used to ship your samples with a “non-hazardous” classification throughout the world, thus reducing costs and helping to assure sample viability.

Key Features

- MVE Protective Shipping Containers are recommended
- Protective shipping containers ensure upright shipping
- Low liquid nitrogen consumption
- Convenient lightweight package
- Safe for international shipping; IATA Dangerous Goods Regulations Exempt (Special Provision A152)
- Charges in 2 hours*



MVE Vapor Shipper Series

	SC 2/IV	SC 4/2V	SC 4/3V	XC 30/12V	Cryo-Shipper	Cryo-Shipper XC	CryoShipper 2000	IATA	65/5V
Maximum Storage Capacity									
○ No. of Canisters	1	1	1	1	1 Rack	-	4 square racks	Stainless Steel Secondary Container Dimensions: 7-3/8" diameter 8-3/4" deep	1x 5/2 vial box rack (100 vials/box)
○ No. of 1/2 cc Straws 10/cane	-	280	120	60		-			
○ No. of 1/2 cc Straws 1 Level Bulk	88	440	210	312		-			
○ No. of 1/4 cc Straws 1 Level Bulk	182	938	452	660		-			
○ No. of 1.2 & 2.0 ml Vials 5/cane	-	95	40	30		-			
○ No. of 1.2 & 2.0 ml Vials 6/cane	-	102	48	36		500	966 (Bulk)		
○ No. of blood bags stored 4R9953	-	-	-	-	10	10			
Performance (Hold Time overrides NER specifications)									
○ LN ₂ Capacity L	1.5	3.6	4.3	18	8.5	10.0	65	10.0	27.4
○ Static Holding Time Days	8	13	21	82	10	14	15	14	40
○ Static Evaporation Rate* L/day	0.19	0.26	0.20	0.22	0.85	0.70	.79	0.70	0.79
Unit Dimensions									
○ Neck Opening in. (mm)	1.40 (35.0)	2.75 (70.0)	2.00 (51.0)	2.00 (51.0)	8.50 (216.0)	8.50 (216.0)	8.5 (216)	8.50 (216.0)	8.50 (216.0)
○ Overall Height in. (mm)	13.5 (343)	18.4 (468)	19.4 (492)	24.3 (617)	21.5 (546)	23.0 (584)	27.2 (692)	23.0 (584)	27.3 (694)
○ Outer Diameter in. (mm)	7.25 (184)	8.70 (222)	8.70 (222)	17.0 (432)	14.50 (369)	15.00 (381)	22.0 (559)	15.00 (381)	22 (559)
○ Canister Height in. (mm)	5.0 (127)	11.0 (279)	11.0 (279)	11 (279)	11.0 (279)	12.5 (317.5)		8.75 (222.25)	-
○ Canister Diameter in. (mm)	1.20 (31)	2.62 (67)	1.81 (46)	1.96 (50)	5.6 (142) x 6.6 (167)***	8.5 (216)		7.375 (187.325)	-
○ Weight Empty lb. (kg)	6.0 (2.7)	10.0 (4.5)	11.6 (5.3)	44 (20)	26.1 (11.8)	33.0 (15.0)	65 (29.5)	33.0 (15.0)	74.5 (33.9)
○ Weight Charged lb. (kg)	8.0 (3.6)	17.1 (7.7)	19.1 (8.7)	76 (34)	39.0 (17.7)	49.0 (22.2)	95 (43.1)	49.0 (22.2)	145.5 (66.2)
○ Weight Full lb. (kg)	9.0 (4.1)	20.0 (9.1)	21.0 (9.5)	82 (37.2)	54.5 (24.7)	73.0 (33.1)	185 (83.9)	73.0 (33.1)	185 (83.9)
○ Protective Shipping Container Part No.	20750408	20750409	20750409	21325842	20750520	10741726	12875162	10741726	12875162

TWO Year Parts Warranty • THREE Year Vacuum Warranty

* Without inventory

*** CryoShipper has a rectangular assembly measuring 5.6" (142 mm) by 6.6" (167 mm) with a usable height of 11.0" (279 mm).

Hold time specs actual performance may vary with atmospheric conditions, sample temperature, and usage.

Conforms to MDD 93/42/EEC, the Medical Device Directive for the EU.

Tank Features

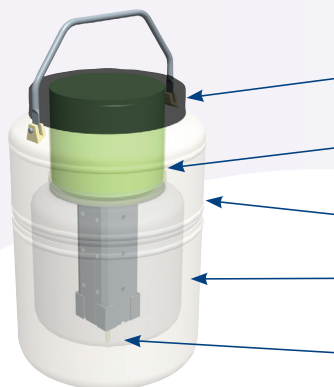

- A** Durable, tamper-proof lid design
- B** High strength neck tube reduces liquid nitrogen loss
- C** Strong, lightweight aluminum construction
- D** Advanced chemical vacuum retention system
- E** Hydrophobic Liquid Nitrogen absorbent system

© 2024 MVE Biological Solutions reserves the right to discontinue its products, or change the prices, materials, equipment, quality, descriptions, specifications and/or processes to its products at any time without prior notice and with no further obligation or consequence. All rights not expressly stated herein are reserved by us, as applicable.



Data Logger

PDF Logger with USB and Bluetooth® interface

With the Data Logger, you require only one single device to monitor temperature during the global transfer of cryobiological goods. MVE also provides the option for the data logger to be preinstalled onto the lids of our MVE vapor shippers.

*Note that the Data Logger adds 0.16 L/day loss rate to any tank to which it is attached.

Key Features

- Records and stores up to 75,500 data points
- High and low alarm settings
- Up to 3 year calibration certificate
- 2 year lifespan
- No additional software or cables needed!
- ISO 19005-1
- Conformity: CE, FCC, RoHS, Safe Transport of Chemical Goods, WEEE



Data Logger

Specifications

○ Dimensions L, W, H in (mm)	3.74 x 1.61 x 0.43 (95 x 41 x 11)
○ Weight lb (g)	0.1 (44)
○ Temperature Range	-200°C to +200°C
○ Accuracy	± 1.4°C [-200°C to -100°C]
○ Resolution	0.1°C
○ Display in (mm)	Multifunction LCD, 0.87 x 0.87 (22 x 22)
○ Case	ABS plastic
○ Battery	Non-replaceable
○ Battery Life	2 years (in core range of 0°C to +25°C; 14 months over full temperature range)
○ Sensor	Pt100 4-wire class A
○ Memory	75,500 data points
○ Interface	USB – PC Universal Serial Bus
○ Evaluation Report	Built-in PDF file generator automatically establishes an evaluation report with embedded data upon connection to a USB port. Complies with the ISO Standard 19005-1 Document Management for the long-term preservation of electronic documents (PDF/A) and FDA 21 CFR Part 11.

ONE Year Warranty - No returns.



MVE 1536 Dry Shipper

Securely Ship Large Volumes of Samples in Vapor

MVE 1536 Dry Shipper incorporates a rigid steel Isoframe that is sized to fit in a wide-body aircraft and can be moved with a pallet jack and/or forklift. Complete with lockable inventory tray to prevent rotation during transit and a lockable lid. A data logger is included as standard to monitor and record sample temperature during transportation or relocation.



Key Features

- Liquid Nitrogen absorbent can be charged for dry shipment
- Hold time up to 20 days when properly charged
- Rigid steel frame can be moved with pallet jack/ forklift
- Sized to fit in a wide-body aircraft
- Inventory tray locks to prevent rotation during transit
- Locking lid
- Includes data logger to monitor and record sample temperature during shipment or relocation

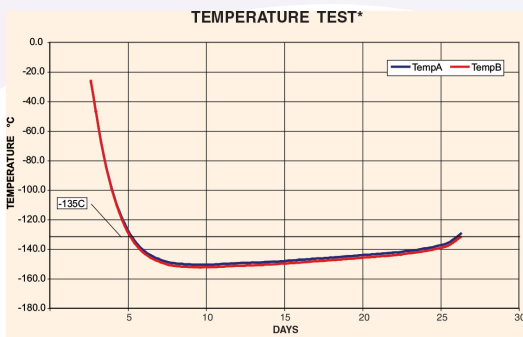

Temperature Test Graph

* Temp Test indicates typical performance of MVE 1536PD freezer with full inventory system and factory recommended level settings. Actual performance may vary with atmospheric conditions and usage.

MVE 1536 Dry Shipper

Maximum Storage Capacity	
○ 1.2 & 2 ml Vials (Internally Threaded)	36400
○ Quantity of Large Racks 100 cell boxes	24
○ Quantity of Mini Racks 25 cell boxes	16
○ Number of Shelves per Rack	13
Performance	
○ Absorbed LN ₂ Capacity L est.	320
Unit Dimensions	
○ Neck Opening in. (mm)	17.5 (444)
○ Usable Internal Height in. (mm)	30 (762)
○ Inner Diameter in. (mm)	38.5 (978)
○ Overall Height including Frame** in. (mm)	64 (1625)
○ Liftover Height in. (mm)	42.1 (1070)
○ Step Height in. (mm)	20.5 (521)
○ Depth of Fold Down Step in. (mm)	10.8 (274)
○ Footprint in. (mm)	52x52 (1321x1321)
○ Weight Empty* lb. (kg)	1600 (726)
○ Weight Liquid Full* lb. (kg) est.	2044 (927)

THREE Year Vacuum Warranty • TWO Year Parts Warranty

Conforms to MDD 93/42/EEC, the Medical Device Directive for the EU. Freezer systems UL/C-UL Listed.

* Without inventory | **Contact Tech Service for detailed drawings.

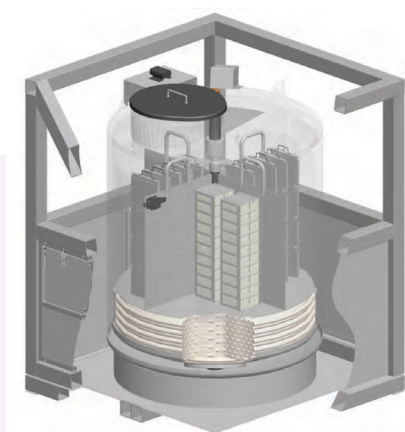

Tank Features



Locking Cabinet



Data Logger



Top View



Tray

Rack Layout

Square Rack Layout

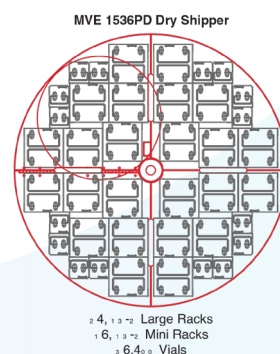

MVE CryoTipper

LN₂ tank transportation and LN₂ dispensing

The MVE CryoTipper introduces a new solution for transporting and dispensing LN₂ for our our cryogenic aluminum tanks. The CryoTipper system is design to transport the tank in the upright configuration regardless of the orientation of the CryoTipper due to the unique design of the CryoTipper's swivel system. Transporting the dewar in the upright configuration increases the safety concerns when transporting tanks such as the risk of spilling LN₂. The CryoTipper's swivel system also enables tipping the dewar completely upside down in order to dispense liquid nitrogen. Heavy duty velcro strap are included to secure the tank into the CryoTipper when being transported or used to dispense LN₂.



Key Features

- Swivel system to enable tipping and inverting the dewar to dispense LN₂ from an MVE liquid tank or vapor shipper
- Heavy duty velcro straps to secure tank into swivel cage system
- Cage system padding to protect the tank from damage
- Rugged rubber wheels for easily transporting tanks on all surfaces
- Adjustable ring to ensure tight fit around the tank

MVE CryoTipper

	Medium	Large
Specifications		
○ Tank Diameter Range in. (mm)	14.5 (368) - 17.0 (432)	17.1 (434) - 20 (508)
○ Model Fit Range	XC-20 Signature - Lab 30	XC 34/18 to XC 47/11
○ Weight lb (kgs)	40.0 (18.1)	50 (22.6)
○ Material	Stainless Steel	Circular Tube
○ Part Number	21714640	21714641

* Tank will fit any dewar model securely within the specified diameter range

* Some assembly required

CryoTipper in Horizontal Position





Visit www.mvebio.com for more information. 1-844-MVE-CRYO



MVE Biological Solutions
3055 Torrington Drive
Ball Ground, GA 30107
Ph +1-470-552-2500
Toll Free +1-844-683-2796
Fax +1-404-383-1901
customerservice.usa@mvebio.com
techservice@mvebio.com

EC REP

Medical Products Service GmbH
Borngrasse 20
35619 Braunfels, Germany
+49-6442-962073

Intended Use & Indication for Use for Cryogenic Storage and/or Transport

LIFE SCIENCE INTENDED USE STATEMENT

STORAGE ONLY

MVE Freezers are intended for the indication of preserving human biological products, samples, and/or specimens (e.g., blood, blood products, cells, tissues, etc.) at cryogenic and ultracold temperatures during storage.

STORAGE AND TRANSPORT

MVE Dewars and Vapor Shippers are intended for the indication of preserving human biological products, samples, and/or specimens (e.g., blood, blood products, cells, tissues, etc.) at cryogenic and ultracold temperatures during storage and/or transportation.



ML-000019 Ver1

© 2024 MVE Biological Solutions reserves the right to discontinue its products, or change the prices, materials, equipment, quality, descriptions, specifications and/or processes to its products at any time without prior notice and with no further obligation or consequence. All rights not expressly stated herein are reserved by us, as applicable.

