



MVE Fusion[®] 800 Series

Technical Manual





Fusion® and QDRIVE® are trademarks or registered trademarks of MVE Biological Solutions US, LLC.

Record the Model and Serial Numbers of all MVE Biological Solutions equipment and date of manufacture. Retain for future reference.

Model No. _____ Serial No. _____ Date: _____

Model No. _____ Serial No. _____ Date: _____

Model No. _____ Serial No. _____ Date: _____

Model No. _____ Serial No. _____ Date: _____

Model No. _____ Serial No. _____ Date: _____





1. Table of Contents

- 1. Introduction..... 6
 - 1.1 Intended use & Indication for Use for Cryogenic Storage 6
 - 1.2 Contraindications..... 6
 - 1.3 Symbols Definitions..... 7
 - 1.4 Graphical User Interface icons 8
 - 1.5 Warnings..... 8
 - 1.6 Precautions..... 9
 - 1.7 Liquid Nitrogen.....11
 - 1.7.1 Liquid Nitrogen Properties.....11
 - 1.7.2 Liquid Nitrogen Safety.....12
 - 1.7.3 Recommended First Aid.....12
 - 1.7.4 Recommended protective clothing13
 - 1.8 Warning Legal Notice13
 - 1.9 Equipment Environments..... 14
 - 1.10 Product Photographs and Drawings 14
- 2. Product Overview15
 - 2.1 Liquefier (QDRIVE Cryocooler)17
 - 2.2 QDRIVE® Cryocooler19
 - 2.3 Fusion Dewar 20
 - 2.4 Pressure Vessel and Sample Storage Area.....22
 - 2.5 Ancillary Equipment.....22
 - 2.6 Temperature Sensor..... 24
 - 2.7 Accessories and Cables 24
 - 2.8 Service ports.....25
 - 2.9 Navigating GUI.....25
- 3. Installation and Startup.....29
 - 3.1 Setup.....29
 - 3.2 Fill Procedure36
- 4. Operation 40
 - 4.1 Routine Operation 40
 - 4.2 Temperature Alarm Setpoint Change procedure 41
 - 4.3 Time and Date setting 41
 - 4.4 Log Data Transfer 43
 - 4.5 Settings 45
 - 4.5.1 Change Language settings..... 45



- 4.5.2 Change password..... 45
- 4.5.3 Password reset..... 46
- 4.5.4 Admin Console 46
- 4.6 Refill/Top-Off Procedure..... 46
- 5. Preventative Maintenance Schedule..... 48
- 6. Alarms (Notifications)..... 49
 - 6.1 Alarms 49
 - 6.2 Alarms and Descriptions 50
 - 6.3 Global Alarm Dry Contacts..... 50
- 7. Troubleshooting 51
- 8. Maintenance Instruction 58
 - 8.1 Liquefier shroud removal..... 59
 - 8.2 Safety relief valves and global valves inspection 61
 - 8.3 Lid, Lid thaw, gasket, and freezer neck gasket inspection 61
 - 8.4 Fusion neck gasket replacement..... 62
 - 8.5 Clear vinyl tube inspection 62
 - 8.6 Dust Removal..... 62
 - 8.7 Temperature probe (RTD) replacement..... 63
 - 8.8 Temperature Calibration..... 64
 - 8.9 Backup Battery Inspection..... 66
 - 8.10 Battery Replacement 68
 - 8.11 Fan Replacement..... 69
 - 8.12 Clear Vinyl Tube Replacement..... 70
 - 8.13 Relief Valve(s) Replacement 72
- 9. Fusion Parts List..... 73
- 10. Technical Specifications..... 73
 - 10.1 Product Specifications..... 73
 - 10.2 Product Environmental Requirements 75
 - 10.3 Electromagnetic Requirements 75
 - 10.4 Essential Performance and Disturbances..... 75
- 11. Taking Fusion Out of Service 76
- 12. End of Life Disposal 79
- 13. Customer Service..... 79



1. Introduction

This technical manual contains essential information regarding the safe and effective operation of the MVE Fusion freezer. This manual is intended to be used by trained and experienced users. Included are instructions for operation, troubleshooting, and maintenance of MVE Fusion freezers.

READ BEFORE USING THIS EQUIPMENT. Failure to follow instructions in this manual may result in damage to the unit, injury to personnel, and/or poor equipment performance. All service and maintenance should be performed by an authorized MVE Distributor or Service Technician.

The MVE manufactured liquid nitrogen freezer covered in this manual is non-hazardous, open-mouth, vacuum-insulated Dewar. It is constructed of stainless steel and aluminum and specifically designed to hold liquid nitrogen.

1.1 Intended use & Indication for Use for Cryogenic Storage

Life Science Intended use statement

Storage Only: MVE Freezers are intended for the indication of preserving human biological products, samples, and/or specimens (e.g., blood, blood products, cells, tissues, etc.) at cryogenic and ultracold temperatures during storage.













1.2 Contraindications

Altitude limitation: The MVE Fusion 800 Series freezer is not intended to operate at altitudes above 1,129 ft (344 m).







**1.3 Symbols Definitions**

	CAUTION – Signifies potentially hazardous situation that may result in minor to moderate injury or property damage		
	WARNING – Signifies potentially hazardous situation that may result in serious injury or property damage		
	Warning; Asphyxiating Atmosphere		Warning; Electricity
	Warning; Low Temperature		Warning; Explosive
	Wear Protective Gloves		Wear a Face Shield
	CE Mark of Low Voltage Directive		Wear an Apron
	Catalog number		Serial number
	European Authorized Representative		Operating Instructions
	Manufacturer		Date of Manufacture
	No Pushing		This Way Up
	Temperature Limit		Humidity Limit
	Biological Risks		No tools required
	Non-ionizing Electromagnetic		
	UL Listed Mark - conforms to UL STD 61010-1 and certified to CSA STD C22.2#61010-1		
	ETL listing mark		
	WEEE symbol European Community directive 2012/19/EC		

**1.4 Graphical User Interface icons**

	Fusion application		Home
	Levels		Alarms
	Calibration		Logs
	Settings – Home screen		Speaker Toggles audible alarm gray (Off) / amber (On)
	Increase setting		Alarm Toggles notifications gray (Off) / amber (On)
	Decrease setting		Clear alarm history
	Android navigation icons – Back, Home, Overview		

1.5 Warnings

- To avoid injury or equipment damage, read and follow all introduction, product overview, installation and startup, and operation sections before installing and operating MVE Freezers. 
- To avoid risk of electrical shock, this equipment must only be connected to a properly grounded power source or outlet. 
- Do not use plug adapters or extension cords. Such devices may defeat the safety ground and could result in injury. 
- Use safety cryogenic gloves, apron, and face shield when opening freezer access lid and handling samples to avoid injury. 
- Protection impairment if used in a manner not specified by the manufacturer. 
- Pinch hazard – use caution when opening and closing the plumbing and electrical enclosures.
- Always wear protective cryogenic gloves, apron, and face shield when handling LN₂ to avoid injury.
- Nitrogen vapor is a potential asphyxiant as it displaces Oxygen (O₂) in confined spaces. Rapid suffocation can occur without warning in an Oxygen-deficient atmosphere (less than 19.5% O₂). MVE Cryogenic Freezers must be installed and operated in well-ventilated areas. DO NOT vent containers in confined spaces. 
- DO NOT enter confined spaces where excess nitrogen gas may be present. 



10. If exposure has occurred, move to ventilated area or fresh air. If breathing is difficult, supplemental oxygen may be required and it is recommended to seek medical attention.
11. Contact with liquid nitrogen or uninsulated equipment containing nitrogen can result in cold contact burns or tissue damage.
12. Nitrogen vapor can cause damage to skin or eyes.
13. In case of frostbite, warm areas with warm water not exceeding 105°F (40°C) and seek medical attention.
14. Do not use equipment in the presence of flammable anesthetics, gases, disinfecting agents, cleaning solutions, or any material susceptible of ignition due to electrical sparking.
15. Ensure that the LN₂ supply valve is closed, and the plumbing assembly is vented before servicing or removing any plumbing fittings or valves.
16. Ensure that the Fusion's LN₂ supply valve is closed and that the pressure within the Fusion's pressure vessel is completely vented to atmosphere before removing the pressure relief valve. Note it may be necessary to refill/top off cryogen within the pressure vessel.
17. Installing a relief valve with a different pressure rating should not be done as it may lead to a dangerous over pressurized condition. Additionally, this will void any warranty.
18. Ensure all moisture is completely removed from the Fusion's plumbing assembly prior to introducing LN₂.
19. LN₂ fill and vent valves on an empty pressure vessel should always be kept closed to protect it from being contaminated with moisture.



NOTE: See Section 1.7 for additional information regarding liquid nitrogen safety.

1.6 Precautions

MVE Freezers are intended for the maintenance of cryogenic temperatures during storage for the indication of preserving human or animal biological products, samples, or specimens (e.g., blood, blood products, cells, tissues, etc.) during storage.

Cryogenic containers must be operated in accordance with the manufacturer/supplier instructions. Cryogenic Dewars must be kept in a well-ventilated area protected from weather and away from heat sources.

NOTE: Failure to follow MVE's best operating practices, as set forth in the technical and quick reference user manuals, can result in loss of contents.



WARNING: Do not modify this equipment without authorization of MVE.



1. Read the entire installation, startup and operation sections before installing and operating the MVE Fusion Freezer.
2. Equipment should only be used in compliance with its intended use.
3. Proper care and handling on a day-to-day basis are extremely important to ensure safe and efficient operation.



4. Always keep the Fusion and all plumbing connections clean and free from grease and oil.
5. Contact your MVE Distributor for any visual and/or audible alarms.
6. The two metal handles that are attached to each side of MVE Fusion freezer and the casters are only for moving an empty freezer. These are not for lifting or moving the MVE Fusion freezer during operation.
7. Do not position the MVE Fusion Freezer where it would be difficult to remove the power cord from power source or outlet.
8. Install the MVE Fusion freezer on a level surface.
9. Equipment must be connected to electrical supply mains with protective earth. The voltage and frequency characteristics must be compatible with those listed on the unit or in this manual.
10. The MVE Fusion freezer should be placed with a minimum clearance of 12 inches (305 mm) on all sides.
11. Do not power On the MVE Fusion freezer without LN₂ inside the pressure vessel. This can cause moisture within the pressure vessel's fill/vent lines to freeze prevent proper filling.
12. The MVE Fusion freezer ships with both isolation valves closed.
13. The MVE Fusion freezer ships with a small amount of nitrogen gas, typically 7 psi (less than 0.5 bar) within the pressure vessel.
14. Ensure all moisture is completely removed from the pressure vessel and the freezer is dry prior to refilling the pressure vessel with liquid nitrogen.
15. The MVE Fusion freezer requires installation of all empty inventory rack systems BEFORE the first liquid nitrogen fill. Do not fill the Fusion without an empty inventory system.
16. If warm racks (room temperature) are installed after the MVE Fusion freezer's first fill or if more than 2 warm racks are installed during its subsequent operation, venting will occur which will result in a loss of liquid nitrogen inside the pressure vessel. Be prepared to have a 230-liter LN₂ cylinder at 22-35 psig (1.52 - 2.41 bar) to refill pressure vessel if this occurs.
17. After the first fill of liquid nitrogen, it can take approximately 36 to 48 hours to cool down the freezer.
18. If the isolation valves are not reopened after filling of the MVE Fusion freezer is complete, the measured "Cryogen Level," "Differential Pressure," and "Gas Pressure" values displayed on the Levels screen (main screen) will not be accurate and venting will occur which will result in a loss of liquid nitrogen.
19. The LN₂ transfer hose should be warm and purged with nitrogen gas prior to connecting to the MVE Fusion freezer to prevent water/ice contamination. MVE recommends having two 230-liter Supply tanks for the first LN₂ fill.
20. Recommended LN₂ supply pressure is 22-35 psig (1.52 - 2.41 bar).
21. The isolation valves should always be closed whenever LN₂ is added to the pressure vessel and reopened after the fill is complete.
22. If the isolation valves are open during the fill the electronics inside the Liquefier could be exposed to LN₂.
23. MVE recommends any cryogen filling/refilling be done by an authorized MVE technician or distributor. Contact MVE Technical service for any questions.
24. Ensure that the freezer access lid's magnetic strip is aligned in the 12 o'clock position facing towards the liquefier.
25. Ensure that the freezer's lid gasket sits flush on top of the neck gasket.



26. The freezer lid removal should be performed slowly to mitigate frost build up and damage to the cork.
27. Thaw the Fusion freezer's lid as recommend within the Preventative Maintenance Schedule and Maintenance Sections 5 & 8 respectively.
28. Never operate the Fusion freezer without the Android running the Fusion application and never exit application during operation.
29. The Fusion's Graphical User Interface (GUI) is not a controller. The software monitors and stores historical data.
30. The MVE Fusion firmware is only updated by authorized MVE Distributor or MVE personnel. Improper firmware updates can render the Fusion inoperable.
31. Follow preventative maintenance schedule to ensure optimal performance.
32. Removal of Fusion liquefier shroud should only be performed by an authorized MVE Distributor or Service Technician.
33. The liquid nitrogen level of the Fusion's pressure vessel can only be verified via the GUI. The liquid nitrogen level in the MVE Fusion freezer cannot be manually verified with a dipstick measurement.
34. MVE recommends resistance temperature detector (RTD) calibration be done by an authorized MVE Distributor or MVE personnel. The RTD probe must be removed from Fusion freezer to be calibrated.
35. If putting the Fusion freezer into long term storage, the equipment must be emptied of LN₂ and completely dry of all moisture. Ensure that no air enters cryogen pressure vessel after it is drained.

1.7 Liquid Nitrogen

Liquid nitrogen (LN₂) is used in MVE Fusion freezers as a refrigerant. Understanding and following certain safety precautions is extremely important when handling LN₂ and Dewar cryogenic containers.

1.7.1 Liquid Nitrogen Properties

Nitrogen is a colorless, odorless, and tasteless gas. Gaseous nitrogen makes up about 78% of the Earth's atmosphere by volume. Once collected, cooled, and isolated, nitrogen can be liquefied.

Table 1: Liquid Nitrogen Properties

Boiling Point at STP	-195.8°C, -320.3°F, 77.4 K
Thermal Conductivity (Gas)	0.026 W/(m·K)
Heat of Vaporization (Liquid)	198.4 kJ/kg
Liquid density at 1 atmosphere	1.782 lbs/L, 807.4 g/L, 808.6 kg/m ³









1.7.2 Liquid Nitrogen Safety

The most important safety aspects to consider when handling LN₂ are adequate ventilation, eye protection, and skin protection. Although nitrogen gas is non-toxic, it is dangerous in high concentrations as it will displace oxygen in a normal breathing atmosphere. Cryogenic liquids are of even greater risk as a small amount of liquid evaporates into a large amount of gas. Therefore, it is imperative that cryogenic supply and storage Dewars be stored and operated in well-ventilated areas.





Transferring LN₂ and operating the MVE Fusion freezer should be done in accordance with the manufacturer/supplier instructions. It is important that all safety precautions recommended by MVE be followed.



- **WARNING:** Do not modify this equipment without authorization from MVE. 
- Nitrogen vapor is a potential asphyxiant as it displaces Oxygen (O₂) in confined spaces. Rapid suffocation can occur without warning in an Oxygen-deficient atmosphere (less than 19.5% O₂). MVE Cryogenic Freezers must be installed and operated in well-ventilated areas. 
- DO NOT vent container in confined spaces. 
- DO NOT enter confined spaces where excess nitrogen gas may be present. 
- If exposure has occurred, move to ventilated area or fresh air. If breathing is difficult, supplemental oxygen may be required and it is recommended to seek medical attention. 
- Contact with liquid nitrogen or uninsulated equipment containing nitrogen can result in cold contact burns or tissue damage. 
- Nitrogen vapor can cause damage to skin and eyes. 
- In case of frostbite, warm areas with warm water not exceeding 105°F (40°C) and seek medical attention. 
- Never place LN₂ in a sealed container without a pressure relief device. The expansion ratio of liquid nitrogen to gaseous nitrogen is 1 to 700 (1 cubic foot of liquid nitrogen becomes 700 cubic feet of gaseous nitrogen when evaporated). 

1.7.3 Recommended First Aid

- Every site that stores and uses LN₂ should have an appropriate Safety Data Sheet (SDS) present. The SDS may be obtained from the LN₂ manufacturer or distributor. The SDS will specify the symptoms of overexposure and first aid to be used. 
- If symptoms of asphyxia such as headache, drowsiness, dizziness, excitation, excess salivation, vomiting, or unconsciousness are observed, move to fresh air. If breathing is difficult, supplemental oxygen may be required and it is recommended to seek medical attention. 



- If exposure to cryogenic liquid occurs, restore tissue to normal, body temperature 98.6°F (37°C) as rapidly as possible, and protect the injured tissue from further damage and infection. 
- Rapid warming of the affected areas is best achieved by bathing in warm water. The temperature of the water used should not exceed 40°C. Under no circumstances should the frozen part be rubbed either before or after warming. If the eyes are involved, flush thoroughly with warm water for at least 15 minutes. In case of massive exposure, remove clothing while showering with warm water.

1.7.4 Recommended protective clothing

Persons transferring LN₂ should make every effort to protect the eyes and skin from accidental contact with liquid or cold vapor. MVE recommends the following protective clothing and accessories when transferring LN₂ or handling hoses, valves, and plumbing components:

- Cryogenic gloves (loose fitting)
- Full-face shield or chemical splash goggles
- Cryogenic apron
- Long sleeve shirt and cuffless pants
- Closed toe shoes



1.8 Warning Legal Notice

NOTE: MVE Fusion Freezer should be installed by an authorized MVE Distributor. Contact your MVE distributor for maintenance and information pertaining to operation and troubleshooting. Additional technical information is available in the Preventative Maintenance Schedule and Maintenance Sections 5 & 8, respectively.

- Failure to follow MVE's best operating practices, as set forth in the operating manual, can result in loss of contents. 
- Active monitoring required.
- Investigate all alarms or abnormal operating conditions immediately and address root causes.
- Contact your Distributor or MVE Technical Support.

NOTE: The EMISSIONS characteristics of this equipment make it suitable for use in industrial areas and hospitals (CISPR 11 class A). If it is used in a residential environment (for which CISPR 11 class B is normally required) this equipment might not offer adequate protection to radio-frequency communication services. The user might need to take mitigation measures, such as relocating or re-orienting the equipment.



1.9 Equipment Environments

MVE Fusion Freezers are suitable for use in the below or similar settings.

- Hospitals and Clinics except for near active HF SURGICAL EQUIPMENT and the RF shielded room of an ME SYSTEM for magnetic resonance imaging, where the intensity of EM DISTURBANCES is high.
- Laboratories
- Cryogenic Storage Facilities
- Universities
- Research Facilities

See Technical Specifications Section 10 for more information.

1.10 Product Photographs and Drawings

The pictures in this manual are for reference only. Items shown may not represent the current product. However, procedural steps are identical, unless otherwise specified.

2. Product Overview

The MVE Fusion freezer is a “self-sustaining” cryogenic storage freezer which requires limited user intervention once installed. There are circumstances (power outages, for instance) when the system will require attention. Alarms and other important information are conveyed by the LCD touchscreen and audible sound. Understanding and familiarizing yourself with the MVE Fusion freezer and its graphical user interface (GUI) is recommended for the user.

The MVE Fusion freezer uses an Android tablet with a custom-built Fusion application to monitor the freezer’s operation.

The MVE Fusion system consists of several key components identified in the figures below.



Figure 1: MVE Fusion 800 Series Freezer



Pressure Relief Valve



Vent Valve

Fill Valve

Figure 2: Fusion 800 Series Freezer Valve Assembly

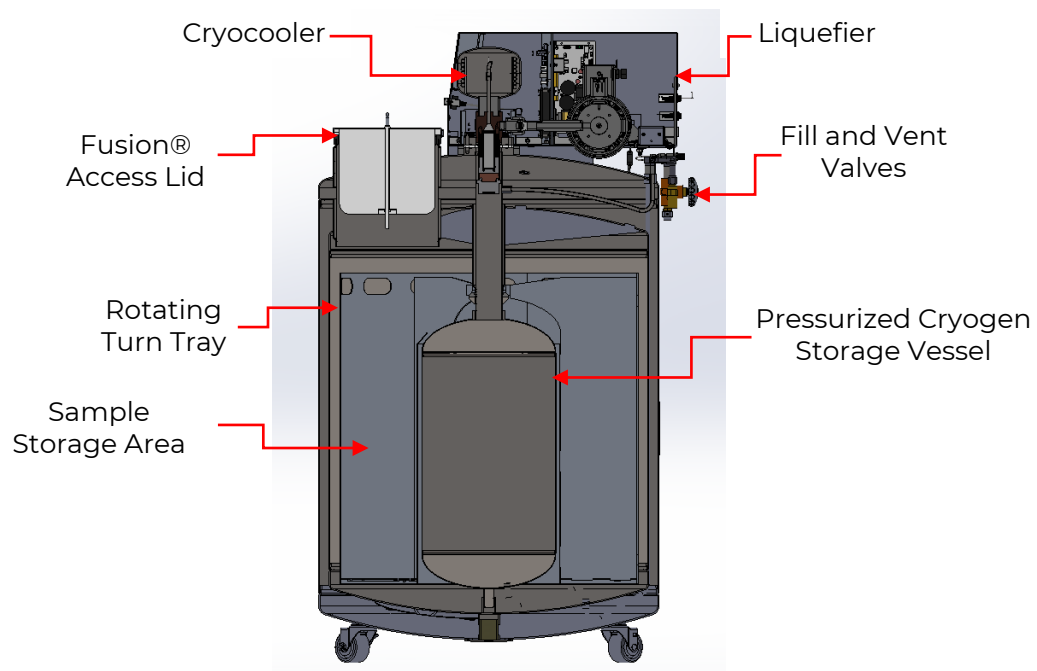

Figure 3: Cross Section of MVE Fusion 800 Series Freezer



2.1 Liquefier (QDRIVE Cryocooler)

The liquefier contains a QDRIVE cryocooler and the other support/interface control systems required to operate the MVE Fusion series freezers. Replacement of a liquefier should only be performed by an authorized MVE distributor or a representative from MVE Biological Solutions.

The liquefier consists of the following major components and features:

- The QDRIVE Cryocooler is the heart of the system and is used to maintain the liquid nitrogen stored within the systems pressure vessel.
- The Graphical User Interface (GUI) is a touch sensitive interface with customized software designed for monitoring the MVE Fusion freezer. The 155 mm x 87 mm screen displays key parameters such as the internal freezer temperature, the cryogen liquid level, QDRIVE cryocooler motor temperatures, the cryogen pressure and system alarms.

NOTE: The GUI is not a controller. The software monitors, displays, and stores historical operation data.

- The battery backup is comprised of two 12V, 9.0Ah, sealed lead acid batteries, wired in parallel. The battery backup allows the LCD touchscreen to remain On to display and collect data in the event of a power outage.
- Running on the backup battery the GUI will continue to show the freezer parameters and alarms for minimally 12 hours without a connection to mains power source.

NOTE: In the event of a power outage the Fusion's QDRIVE cryocooler is not powered by the backup batteries.

- The control board is a printed circuited board (PCB) with control logic and memory for storage of settings and parameters.
- Variable Frequency Drive (VFD) – The QDRIVE cryocooler is powered by a variable frequency, variable voltage power supply. Control of the VFD is accomplished from the control board and is based on the freezer status. Voltage to the QDRIVE cryocooler is modulated to maintain a constant freezer temperature and optimize power consumption.
- Cooling Fans – Fans with heat exchangers reject heat from the QDRIVE cryocooler and electrical components within Liquefier to the ambient environment.
- Alarms – In addition to the visual alarms displayed on the GUI, an audible alarm sounds when any preset threshold (freezer temperature, low battery, motor temperature, VFD temperature, gas pressure, etc.) is exceeded or if the freezer lid has been removed for more than 5 minutes.
- Serial Communication – Two communication ports are provided to externally monitor operational parameters. These are intended for use by trained service technicians or other MVE certified personnel only.
- USB port – A standard USB interface allows access to download the event historical logs. This port is not intended for any other functions.



- Global Alarm Contacts – A normally open and normally closed set of dry contacts are provided for monitoring alarm conditions that can interface with many commercially available remote alarm systems.

NOTE: At this time, MVE Biological Solutions does not provide remote monitoring systems or programmable logic controller (PLC) on the Fusion freezer.

2.2 QDRIVE® Cryocooler

The cryogenic cooler is the refrigeration device for the MVE Fusion series. It is mounted on top of the MVE Fusion Dewar. It provides cryogenic cooling by mechanically compressing and acoustically expanding the helium gas in a thermodynamic Stirling cycle. The base QDRIVE cryocooler unit consists of a pressure wave generator (PWG) and a coaxial Stirling pulse-tube cold head. As liquid nitrogen boils off, it rises to the top of the pressurized inner LN₂ storage tank. Heat is removed from the gaseous nitrogen by the QDRIVE cryocooler and converted back into a liquid. This highly efficient design eliminates the need for a constant supply of LN₂ and allows for autonomous operation. Schematic representation below:



Figure 4: QDRIVE Cryocooler System

The QDRIVE cryocooler system operates as follows:

1. Helium gas is cyclically compressed and expanded relative to the mean pressure by the pistons of the PWG.
2. With each forward stroke of the piston, helium gas moves through the first warm heat exchanger (the “aftercooler”) where heat is removed. Helium is next forced through the regenerator, which precools the gas before it reaches the cold heat exchanger.

3. As the gas moves toward the cold heat exchanger, gas in the acoustic network also moves in the same direction. Even as the driven gas stops advancing, when the pistons reach their upper limits, the helium gas continues moving in the inertance tube, driven by its own inertia. This acts like a virtual piston, moving away from the cold exchanger, expanding the cold gas. As the cold gas expands, it gathers heat from the surroundings (the area or substance to be cooled).
4. The pistons begin withdrawing, and helium moves back through the regenerator and aftercooler. Still delayed by its inertia, the gas in the inertance tube follows, and the cycle begins again.
5. The heat exchangers and pressure wave generator are cooled by fans which blow air over the motor enclosure and the main heat rejection core.

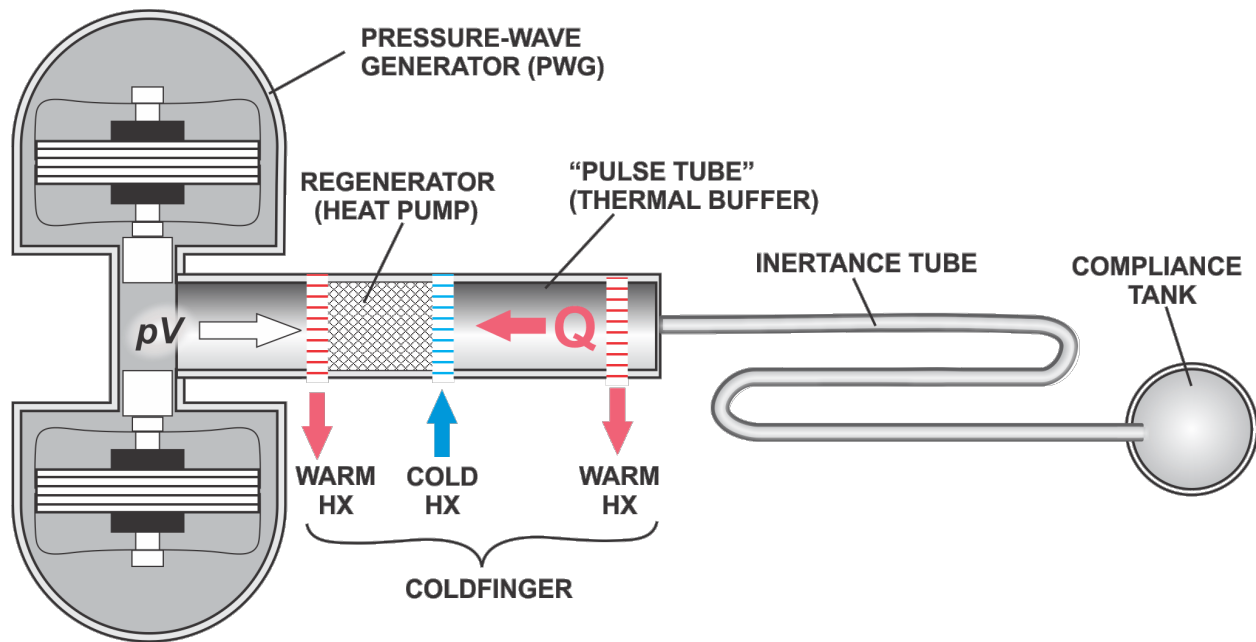

Figure 5: Schematic cross section QDRIVE Cryocooler.

2.3 Fusion Dewar

MVE Biological Solutions is the leading global manufacturer of vacuum insulated biological storage freezers. Standard MVE freezers use liquid nitrogen as the cooling medium; it boils off as heat leaks in from the outside. This process maintains the internal temperature but requires a constant replenishing of liquid nitrogen within the storage space. This limits installations to areas where LN₂ is readily available and easily transported to each freezer location for continual operation of the freezer. The Fusion leverages MVE's vast experience and industry leading technology by incorporating these already proven freezers into a freezer that runs solely on electricity.

The difference is that an internal cryogen storage pressure vessel is added along with a QDRIVE cryocooler to maintain the cryogen in a liquid state. The MVE Dewar consists of the following major components and features:

- Stainless Steel Construction – All storage and pressure vessel components are constructed out of welded stainless-steel offering decades of service life.



- Vacuum Insulation – The annular space around the sample storage compartment is vacuum insulated to minimize conduction and nearly eliminate convection losses.
- Access Lid with Cork – Light, easily removable lid with magnetic strip which interacts with a switch on the liquefier to indicate when the lid has been removed or improperly placed.
- Storage Space – The MVE Fusion is designed with a rotating turn tray, which allows access to all samples without difficulty. The LN₂ dip stick channel guide is not incorporated in the Fusion as LN₂ below the turn tray is not a requirement for operation.
- Temperature Monitoring – One temperature probe, a resistance temperature detector (RTD), is provided to monitor the upper storage space temperature.
- Cryogen Storage Pressure Vessel – Liquid nitrogen storage tank is designed to meet ASME and PED standards with two safety pressure relief devices.
- Liquid Level Sensing – Differential pressure sensors continuously monitor the liquid nitrogen level. Factory calibrated only; no field level calibration is required.
- Fill and Vent Ports – Easily accessible valves are provided for initial filling and venting of liquid nitrogen (refer to the figure 6 below).



Figure 6: Fusion® 800 Series Valves

2.4 Pressure Vessel and Sample Storage Area

The Fusion Dewar is based on MVE’s High Efficiency Freezer, with modifications to incorporate the cryogen pressure vessel and the QDRIVE cryocooler. The turn tray is suspended from the cryogen tank neck and can be turned easily using the turn tray handles. The inner cryogen tank is filled nearly to the top with liquid nitrogen, so that the entire outside of the tank serves as a heat-exchange surface to cool air inside the storage space. The initial fill of the cryogen tank is performed when the Fusion freezer is first delivered and set up by an authorized MVE Distributor or MVE personnel.

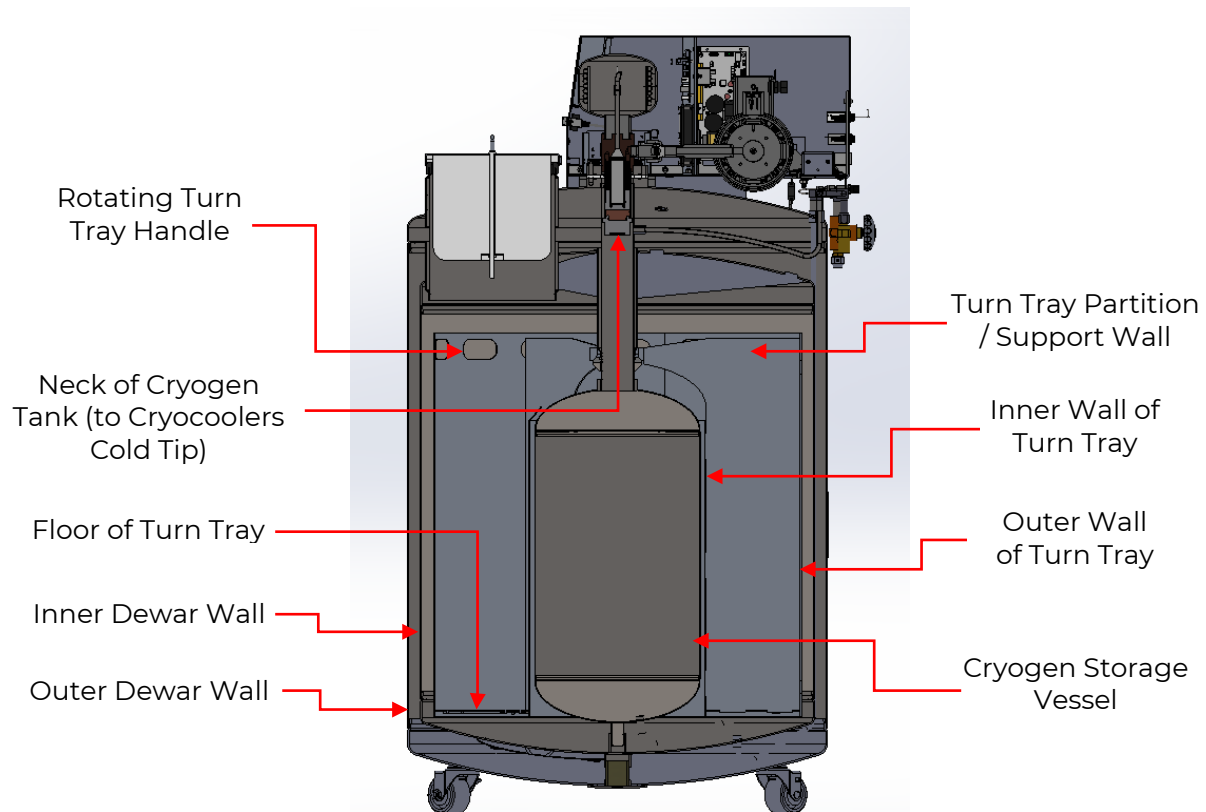

Figure 7: Cross section view Dewar and Cryogen Storage Vessel

2.5 Ancillary Equipment

- **Lid and Cork** – The Fusion freezer lid covers the sample storage access neck. The gasket on the rim of the Dewar neck and the gasket underneath the lip of freezer lid provide insulation and a nearly airtight seal to prevent heat and moisture from entering sample storage area. The system is equipped with a five-minute freezer lid open alarm. The lid is equipped with a vacuum relief valve. This valve assist in the removal of the lid when a vacuum is pulled on the sample space. This can occur during first fill or topping off of the Fusion. This valve is shipped in the closed position and should only be opened when vacuum relief is needed. Failure to keep valve closed will result in the ingress of moisture and build up of ice within the Fusion.



Figure 8: Freezer Lid Installed (Correct Orientation)

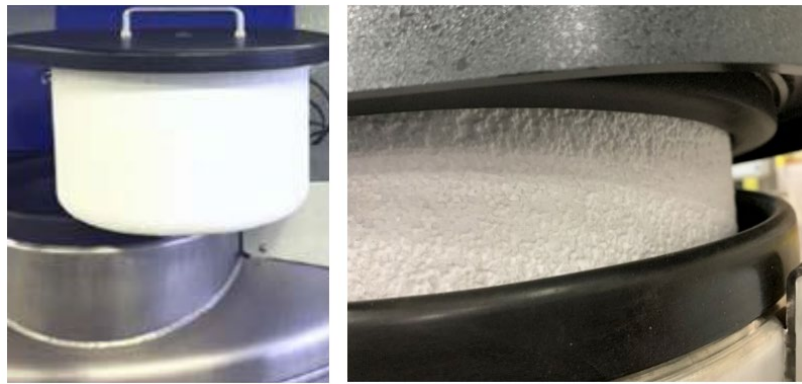

Figure 9: Fusion Freezer lid and cork (gaskets visible on right)

- Transfer line – In the event that the MVE Fusion freezer needs refilling or topping off (after prolonged electrical power source outage), a liquid nitrogen cryogenic transfer hose having a ½” flare fittings on each end and a pressure relief valve should be used to transfer LN₂ from a supply tank to the depressurized cryogen storage vessel. For additional details see Section 4.6 Refill / top-off procedure. MVE recommends using a transfer hose having a “candy cane” pressure-relief valve (like that pictured below) included to protect against hose rupture should the liquid inside become gaseous.



Figure 100: Transfer line

2.6 Temperature Sensor

The MVE Fusion Freezer is equipped with a Resistance Temperature Detector (RTD) that connects to rear of the Liquefier shroud. The RTD probe is supplied by MVE and is factory installed and calibrated. Silicone is added to prevent moisture ingress. The temperature probe tube contacts the inside of the sample storage area to read a temperature consistent with the expected top box temperature of a 13-2 rack placed on the turn tray, located directly under the lid.

An additional, secondary sensor tube port can accommodate a secondary temperature probe based on customer's requirements. See section 8.11 for more details.

If the MVE supplied RTD has any issues or requires calibration, please contact your authorized MVE distributor or Technical Service. Only MVE RTDs are compatible with Fusion electronics; in addition to the size requirement, the probe must be a shielded two-wire (+ and – signal wires, and shield), “PT1000” type, having a nominal resistance of 1000 ohm at 0 ° C.



CAUTION: If no additional sensor is added into the secondary sensor tube, it needs to be sealed with a rubber plug and/or silicone. This helps prevent ambient air and moisture from being drawn into the tube.

NOTE: For an aftermarket temperature sensor, the maximum rigid sensor sheath size at the end of the cable should be 3/16 inches (4.7mm) OD x 1.5 inches (38mm) long. The cable size cannot exceed the diameter of the sheath.



Figure 11: RTD connected to the Liquefier shroud



Figure 12: Temperature sensor ports with yellow plug for aftermarket sensor

2.7 Accessories and Cables

WARNING: Use of accessories, transducers, and cables other than those specified or provided by the manufacturer of this equipment could result in increased electromagnetic emissions or decreased electromagnetic immunity of this equipment and result in improper operation.



Replaceable accessories and cables are listed below:

- 6ft NEMA 5-15P to IEC320C13, Power Cable
- 7in Android LCD Touchscreen

- RTD type PT 1000
- SLA Batteries

2.8 Service ports

For advance troubleshooting, Fusion has additional service ports on back panel that allows authorized MVE Distributor or Service Technicians to connect a computer to retrieve detailed real time data and error codes.

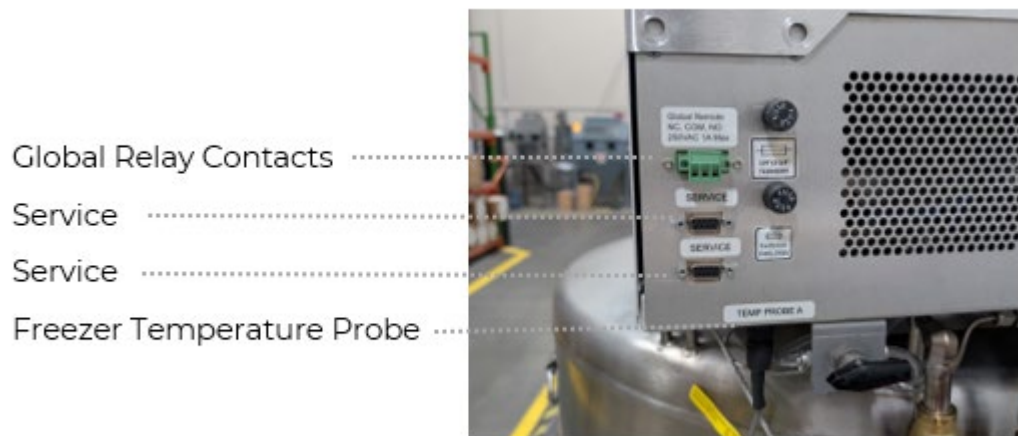

Figure 13: Service Ports

2.9 Navigating GUI

The Fusion GUI consists of a touch sensitive LCD display. It is for system monitoring only. It is not a controller. Swipe and tap the touchscreen to navigate through the GUI and interact with the menu options.

The touchscreen should only be actuated by fingers. Using pens or other pointed objects may damage the screen.



The upper blue portion of the touchscreen remains static on each screen. Tap any menu icon to navigate to any of six screens.

Below is a summary of each of the Fusion screens.



Home (Main) Screen



NOTE: The visual and audible alarms will only mute for a period of 5 minutes. Thereafter, alarms will again be displayed until the root cause of the alarm is addressed.



Levels screen

Displays the current operational status of the Fusion freezer.

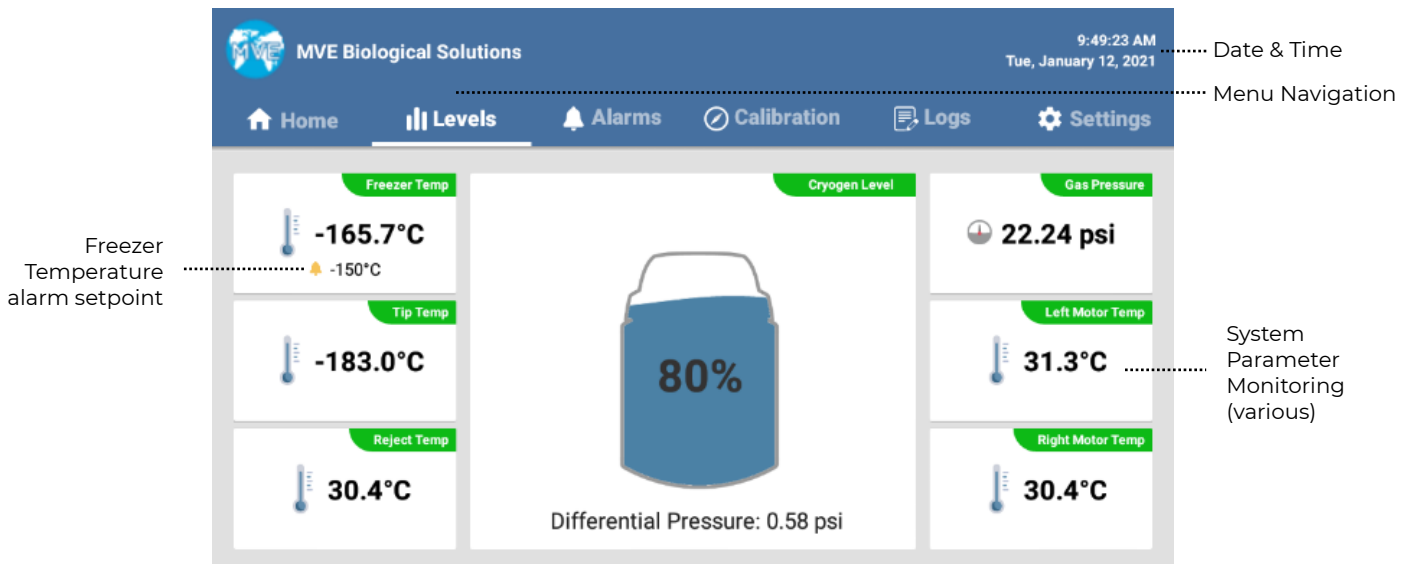



Alarms screen

Allows the user to view historical list of system alarms. See Alarms section 6 for specific alarm details. To clear all messages in “Alarms” screen. Tap “clear” icon in the bottom-right corner.

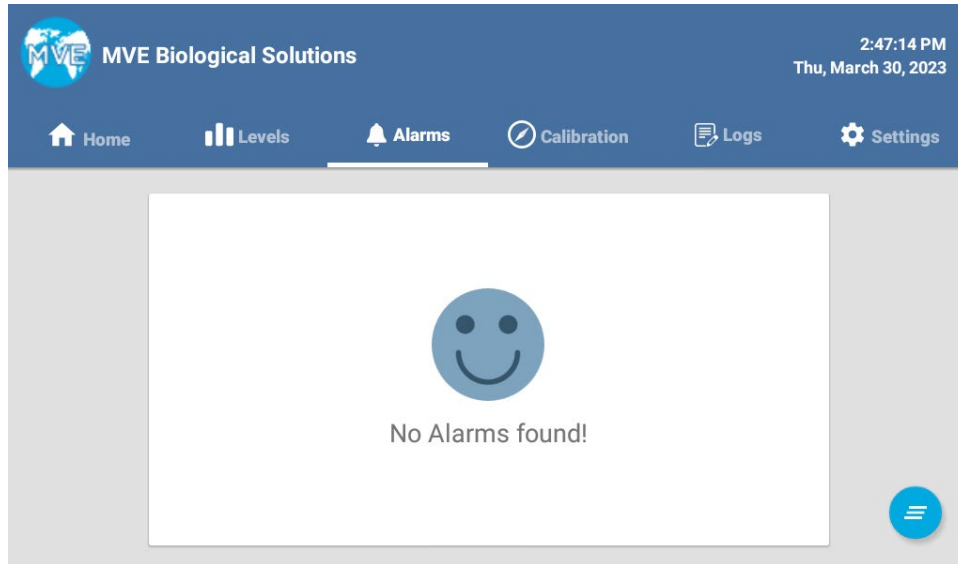

Calibration screen

Only authorized MVE distributor and/or MVE personnel should calibrate the built-in resistance temperature detector (RTD) that comes with the MVE Fusion freezer.

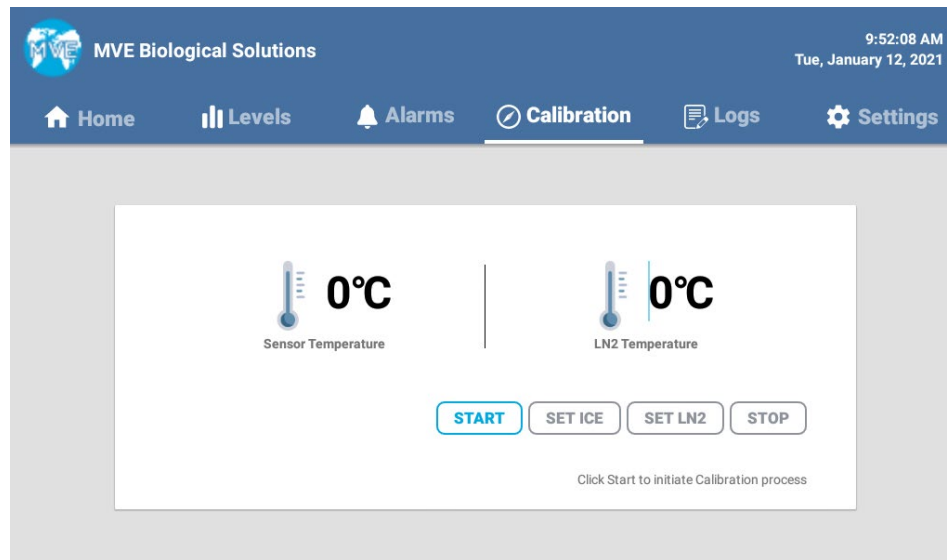

 Log screen

Allows the user to export system data to external drives by connecting a storage device to the USB port. The default password is Fusion01.

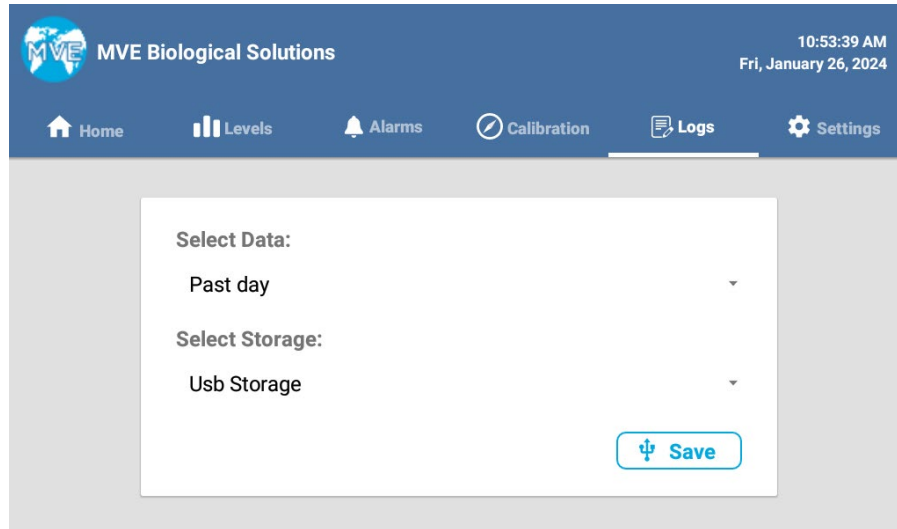

 Settings

Allows users to change the display language and password, reset password, access Admin console, view Open-source Licenses, and view About menu. See the Settings section 4.5 for more details.

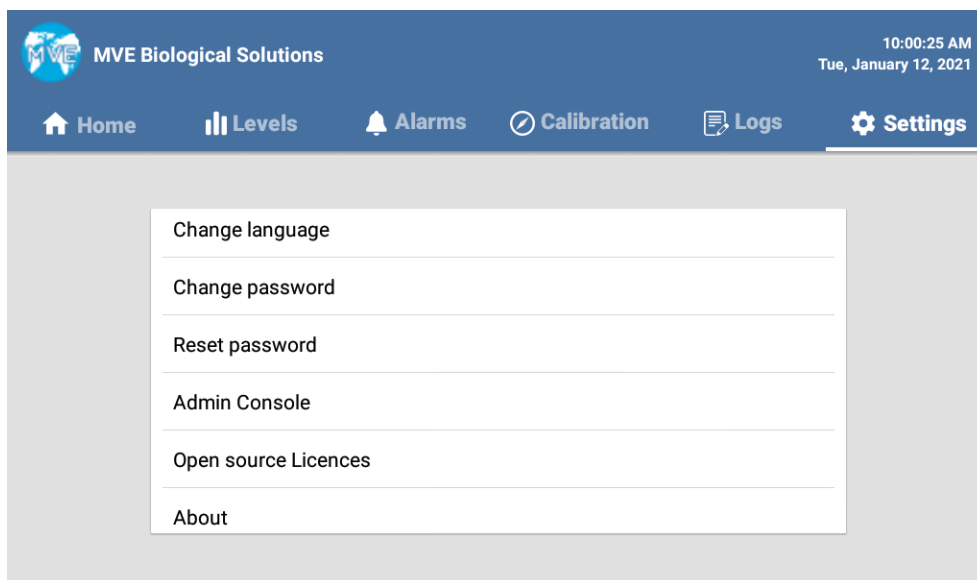



3. Installation and Startup

Read entire installation, startup, and operation section before installing and operating MVE Fusion Freezer.



Always inspect the bill of lading for accuracy and external crate packaging for damage before accepting the shipment.

Included with each MVE Fusion Freezer:

- Literature Packet
 - Fusion Quick Reference User Manual – PN 21205647
 - Warranty Statement / Certificate
- 6-foot transfer hose with “candy cane” pressure relief valve (inside freezer)
- Silicone tube
- A/C Fusion electrical power cords (NEMA 5-15P and IEC 884/CEE7-VII)
 - For Japanese Market power cord (NEMA 5-15P 15 amp rated)
- Liquid Nitrogen handling instructions
- Desiccant bag (inside freezer) – To be removed and discarded before use
- MVE Certificate of Quality

3.1 Setup

1. Place the freezer on level surface in a well-ventilated area.

NOTE: Two handles that are attached on each side and casters are only for moving an empty freezer.

2. The freezer must have clearance of at least 12 inches (305 mm) on all sides. Additional room will be required for LN₂ supply tanks.

2.1 The recommended LN₂ supply pressure is 22-35 psig (1.52 - 2.41 bar). MVE recommends having two 230-liter supply tanks for the first fill.

3. The freezer must be located near properly grounded power source or outlet.



WARNING: The MVE Fusion freezer requires installation of all inventory rack systems before first LN₂ fill! MVE recommends to not fill the Fusion freezer without an inventory system installed.



CAUTION: Do not position the MVE Fusion freezer in an orientation that makes it difficult to remove the power cord from power source or outlet.



WARNING: Do not modify the MVE Fusion freezer without authorization from the manufacturer.



NOTE: Do not power on the MVE Fusion freezer until it has been filled and all steps outlined for first fill have been completed.

WARNING: The MVE Fusion freezer's pressure vessel must be filled with LN₂ before mains electrical power is applied.



WARNING: The MVE Fusion freezer's pressure vessel must be filled with LN₂ before adding LN₂ inside the sample storage space. Failure to do so can potentially cause an ice blockage to occur within the pressure vessel's fill/vent lines and result in users not being able to perform the first fill.

CAUTION: Always wear protective cryogenic gloves, apron and face shield when working with cryogenic liquids, during the first fill or topping off the Fusion freezer.



4. Remove all documentation, hoses and desiccant from storage space.
5. Record model number, serial number and date of purchase on page 2 of this manual.
6. Load all racks and empty boxes or alternate inventory systems into the MVE Fusion's turn tray.



Figure 14: View inside Fusion® 800 Series Sample storage area with inventory systems

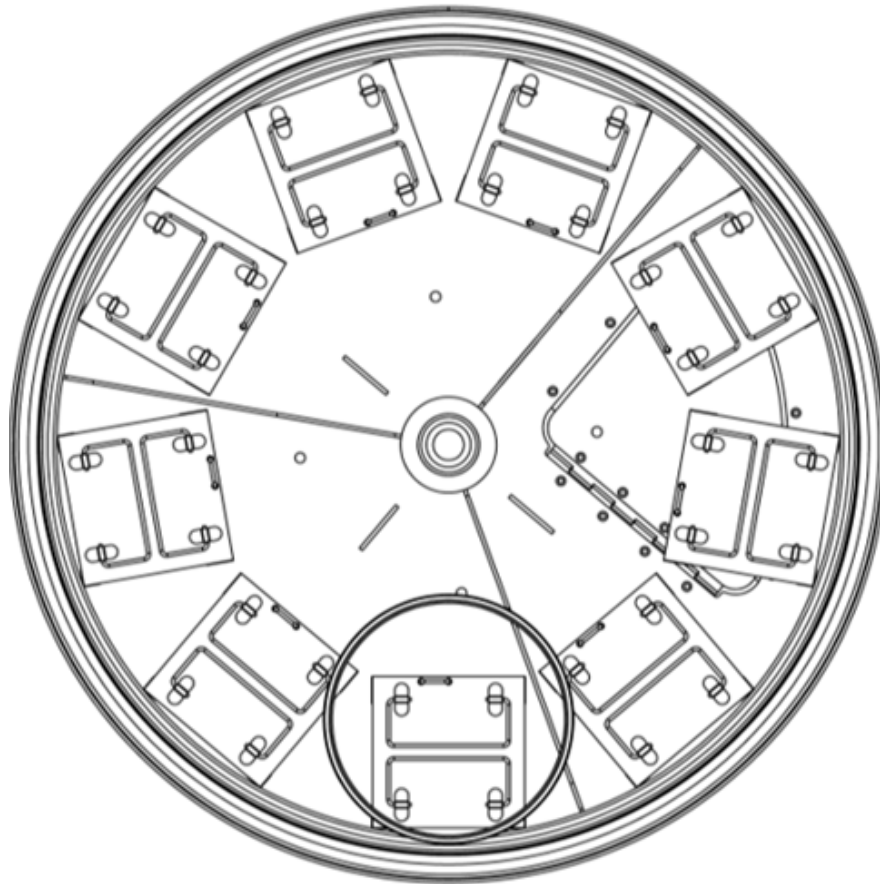

Figure 125: Inventory system layout (a) Fusion 800 Series, qty 9, 13-2 Large Racks

7. Connect the candy cane end of the transfer hose to the LN₂ supply tank.
8. Verify that the “candy cane” is oriented in the vertical position to vent pressure downwards.
9. Briefly purge the transfer hose with gaseous nitrogen from the LN₂ supply tank.
10. Connect the other end of the transfer hose to the Fusion’s inlet fill valve. Refer to the figure below.



Figure 136: Connections

- 11. Confirm both isolation valves, located underneath liquefier shroud, are closed (see figures below).

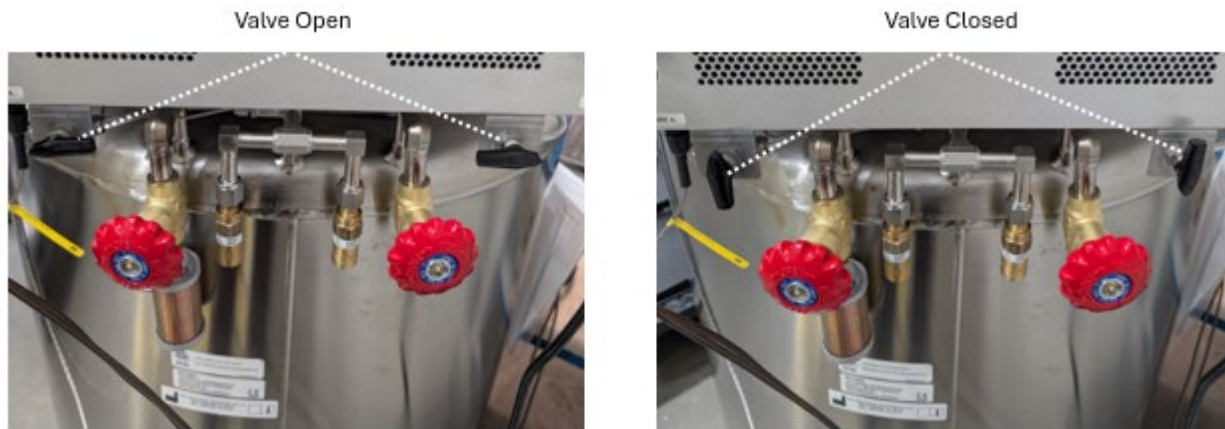

Figure 17: Isolation valve: Both valves in the open, horizontal position (left), both valves in the closed, vertical position (right)

NOTE: The purpose of closing the isolation valves is to isolate Fusion electronics from potential exposure to liquid during the LN₂ fill and top off processes. MVE ships the Fusion freezer with both isolation valves closed after adding a small amount of nitrogen gas, less than 7 psi (< 0.5 bar).

WARNING: If the isolation valves are open during the fill, there is potential for the electronics inside Liquefier be exposed to liquid. If isolation valves are not reopened after the fill, the measured “Cryogen level”,





“Differential Pressure”, and “Gas Pressure” values displayed on the Level screen will be incorrect and venting of the cryogen could occur.

12. Open lid valve shown in figure below.



13. Open liquid supply valve on 230-liter supply tank.

14. On the rear of Fusion freezer, open the vent port by turning the knob counterclockwise. This will release the pressure in the cryogen pressure vessel to prevent over pressurization.



NOTE: When the vent valve is opened, a brief audible venting noise may occur.

15. Open the LN₂ fill port by turning the fill valve counterclockwise. Both the LN₂ fill and vent ports should remain open until the cryogen storage vessel is filled with LN₂ (approximately 35 to 45 minutes).

Pressure Relief Valves



Vent Port

LN2 Fill Valve

Figure 18: Vent port, dual Pressure relief valves, LN₂ fill valve

16. While the Fusion freezer’s cryogen pressure vessel is being filled, use a second liquid nitrogen cylinder with a second LN₂ transfer hose and phase separator (not supplied), to precool inventory system (racks and boxes)





within the sample storage area. To help cool down Fusion freezer faster and minimize venting.

- 17. Rotate the turn tray containing the empty racks/inventory system in the sample storage area while the LN₂ is being dispensed. Spraying LN₂ directly over the top of inventory system helps reduce the cooldown time but should be avoided if samples are present. This will help cooldown the inventory system and storage space, as well as reduce the system pressure build up that may cause the relief valves to vent. 
- 18. Once LN₂ appears to flow from the vent port muffler, close the Fusion’s vent valve.
- 19. Close the Fusion’s LN₂ fill valve.
- 20. Close LN₂ supply tank’s liquid valve.

NOTE: Once the Fusion’s cryogen storage vessel has completed its first fill, the pressure relief valves may vent. This is because both the freezer and inventory system are warm (room temperature). It can take approximately 36 to 48 hours to cool down the Fusion freezer’s contents completely. During this time, the pressure relief valves will open intermittently to vent pressure.

- 21. The Fusion’s cryogen storage vessel is now filled.
- 22. Install the freezer lid. Assure that the lid lock hole, located on the lid, aligns with the lid lock tab located on the freezer’s neck. This will help align the magnet on the lid to the lid’s proximity switch.
- 23. Open both isolation valves.

WARNING: Fusion freezer must be connected to mains electrical power supply with protective earth. Voltage and frequency characteristics must be compatible with those listed on freezer or this manual. Do not use plug adapters or extension cords. Such devices may defeat the safety ground and could result in injury.

Table 2: Power Cable Rating

Region	Power Cable Ratings
USA	125 V, 15A, 16 AWG

- 24. Connect Fusion power cord to MVE Fusion freezer input power receptacle at the rear.



Figure 19: Power cord connected to Fusion® input power receptacle

25. Switch On System Main Power, then the battery backup (“BB Enable/Disable”) power switches.

- The battery backup will begin charging and the LCD touchscreen will initiate its startup sequence.

NOTE: Fusion system pressure and temperature take time to equalize and record/display accurate readings. If the pressure is approximately 22 to 30psi (1.5 to 2bar), the touchscreen Cryogen level should be accurate. If the pressure is too high or too low touchscreen Cryogen level will be incorrect.

- Wait approximately 24 hours to refill/top off pressurized cryogen storage vessel. The refill/top off procedure is outlined below. It can take up to 48 hours to cooldown the entire freezer with a warm inventory system installed.

NOTE: If LN₂ is pooled under the turn tray during cool down process, Cryogen level will not be accurate until the excess LN₂ evaporates. The combination of LN₂ inside the pressure vessel and pressurized cryogen storage vessel’s annular lines being submerged in LN₂ under the Fusion’s turn tray alter cryogen level on GUI.

- The Fusion freezer’s pressure relief valves will begin to release gaseous nitrogen as the liquid boils off and the pressure may build (above 50 PSIG) inside of the storage tank. After the internal chamber and storage racks cooldown to -150°C or less, the “relief” events should subside.

WARNING: If warm racks (Room temperature) are installed after the Fusion’s first fill, and if 1 or more warm racks are installed during its subsequent operation, venting will occur which will result in a loss of liquid inside the pressure vessel. Be prepared to have a 230 Liter LN₂ cylinder at 22-35 PSIG (1.52 - 2.41 bar) to refill the pressure vessel if this occurs.

CAUTION: If the isolation valves are not reopened after the fill is complete, the measured “Cryogen Level,” “Differential Pressure” and “Gas Pressure” values displayed on the Levels screen (Main screen) will be incorrect.





CAUTION: Once the Fusion freezer temperature reaches -150°C (or colder), the insertion of “one” standard, 13-2 square rack with boxes at room temperature without the loss of nitrogen or lifting of the pressure relief valve, allows system to properly function as designed. Insertion of two room temperature racks with boxes will cause the pressure relief valve to lift and loss of nitrogen to occur. Insertion of 20 warm racks will cause pressure relief valve to lift and venting to occur for an extended period of time. The lengthy venting and flow of cold gas out of Pressure relief valve can cause it to freeze open. This will result in it continuing to vent until the pressure within the pressure vessel reaches atmospheric pressure. Thereafter, the pressure relief valve may remain frozen open until it thaws and can close. This may result in the venting of all LN_2 within the Fusion’s pressure vessel. Therefore, it is important to load an empty inventory system before filling.

WARNING: To avoid the risk of electrical shock, this equipment must only be connected to a properly grounded power source or outlet.



CAUTION: Do not position the Fusion freezer in an orientation that makes it difficult to remove the power cord from power source or outlet. Unit should be placed with a clearance of 12 inches (305mm) on each side.

3.2 Fill Procedure

26. After the supply line has been connected to the supply tank, purged of moisture, connected to the Fusion freezer’s fill valve, and close the isolation valves, remove freezer lid or position freezer lid in tilt like position on freezer’s neck. 
27. Open liquid supply valve on 230-liter LN_2 supply tank to 22-35 psi (1.5 to 2.4 bar). 
28. On the rear of Fusion freezer, open vent port by turning knob counterclockwise. This will release the pressure to prevent over pressurization. 

NOTE: When vent valve is opened, a brief audible venting noise may occur.

29. Open the LN_2 fill port by turning it counterclockwise. Both LN_2 fill and vent ports should remain open until the cryogen storage vessel is filled with LN_2 (approximately 35 to 45 minutes).

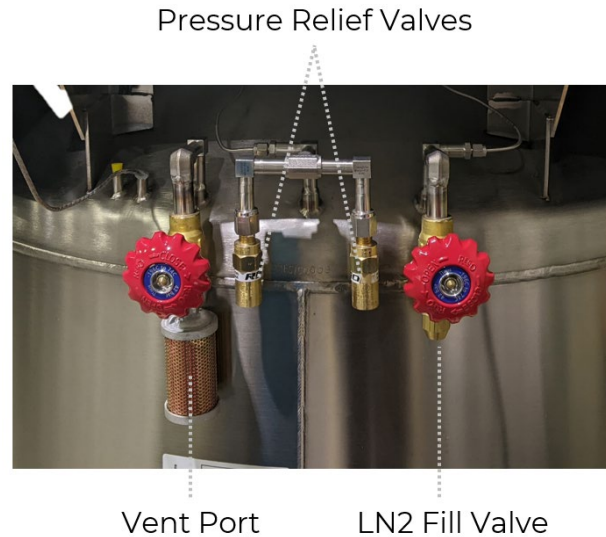



Figure 20: Vent port, dual Pressure relief valves, LN₂ fill valve

NOTE: Once the Fusion's cryogen storage vessel has been filled, the pressure relief valves will begin to intermittently vent gas. This is because both the freezer and inventory system are warm (room temperature). It can take approximately 36 to 48 hours to cool down the Fusion freezer's contents completely. During this time, the pressure relief valves will open intermittently to audible vent pressure.

30. To help cool down Fusion freezer faster and minimize venting, use a second liquid nitrogen cylinder with a second LN₂ transfer hose and phase separator  (not supplied), to spray inventory system (racks and boxes) within the sample storage area.
31. Rotate the turn tray containing empty racks/inventory system in sample storage area while LN₂ is being dispensed. Spraying LN₂ directly over the top of inventory system helps reduce cooldown time but should be avoided if samples are present. This will help cooldown the inventory system and storage space, as well as reduce the system pressure build up that may cause the relief valves to vent. 
32. Once LN₂ appears to flow from the vent port muffler, close the Fusion's vent valve.
33. Close the Fusion's LN₂ fill port.
34. Close LN₂ supply tank's liquid valve.
35. The Fusion's cryogen storage vessel is now filled.
36. Install the freezer lid. Assure that the lid lock hole, located on the lid, aligns with the lid lock tab located on the freezer's neck. This will help align the magnet on the lid to the lid's proximity switch.
37. Open both isolation valves.

WARNING: Fusion freezer must be connected to mains electrical power supply with protective earth. Voltage and frequency characteristics must be compatible with those listed on freezer or this manual. Do not use plug



adapters or extension cords. Such devices may defeat the safety ground and could result in injury.



Figure 14: Freezer Lid proximity switch location

Table 3: Power Cable Rating

Region	Power Cable Ratings
USA	125 V, 15A, 16 AWG

38. Connect Fusion power cord to MVE Fusion freezer input power receptacle at the rear.



Figure 21: Power cord connected to Fusion® input power receptacle

39. Switch On System Main Power, then the battery backup (“BB Enable/Disable”) power switches.

- The battery backup will begin charging and the LCD touchscreen will initiate its startup sequence.

NOTE: Fusion system pressure and temperature take time to equalize and record/display accurate readings. If the pressure is approximately 22 to 30psi (1.5 to 2bar), the touchscreen Cryogen level should be accurate. If the pressure is too high or too low touchscreen Cryogen level will be incorrect.



- Wait approximately 24 hours to refill/top off pressurized cryogen storage vessel. The refill/top off procedure is outlined below. It can take up to 48 hours to cooldown the entire freezer with a warm inventory system installed.

NOTE: If LN₂ is pooled under the turn tray during cool down process, Cryogen level will not be accurate until the excess LN₂ evaporates. The combination of LN₂ inside the pressure vessel and pressurized cryogen storage vessel's annular lines being submerged in LN₂ under the Fusion's turn tray alter cryogen level on GUI.

- The Fusion freezer's pressure relief valves will begin to release gaseous nitrogen as the liquid boils off and the pressure may build (above 50 PSIG) inside of the storage tank. After the internal chamber and storage racks cooldown to -150°C or less, the "relief" events should subside.

WARNING: If warm racks (Room temperature) are installed after the Fusion's first fill, and if 1 or more warm racks are installed during its subsequent operation, venting will occur which will result in a loss of liquid inside the pressure vessel. Be prepared to have a 230 Liter LN₂ cylinder at 22-35 PSIG (1.52 - 2.41 bar) to refill the pressure vessel if this occurs.

CAUTION: If the isolation valves are not reopened after the fill is complete, the measured "Cryogen Level," "Differential Pressure" and "Gas Pressure" values displayed on the Levels screen (Main screen) will be incorrect.

CAUTION: Once the Fusion freezer temperature reaches -150°C (or colder), the insertion of "one" standard, 13-2 square rack with boxes at room temperature without the loss of nitrogen or lifting of the pressure relief valve, allows system to properly function as designed. Insertion of two room temperature racks with boxes will cause the pressure relief valve to lift and loss of nitrogen to occur. Insertion of 20 warm racks will cause pressure relief valve to lift and venting to occur for an extended period of time. The lengthy venting and flow of cold gas out of Pressure relief valve can cause it to freeze open. This will result in it continuing to vent until the pressure within the pressure vessel reaches atmospheric pressure. Thereafter, the pressure relief valve may remain frozen open until it thaws and can close. This may result in the venting of all LN₂ within the Fusion's pressure vessel. Therefore, it is important to load an empty inventory system before filling.

WARNING: To avoid the risk of electrical shock, this equipment must only be connected to a properly grounded power source or outlet.

CAUTION: Do not position the Fusion freezer in an orientation that makes it difficult to remove the power cord from power source or outlet. Unit should be placed with a clearance of 12 inches (305mm) on each side.



4. Operation

4.1 Routine Operation

Under normal operation, MVE's Fusion freezer operates without any user intervention. The user can simply load (pre-cooled to -150°C recommended) racks and samples or remove samples from the sample storage area as desired. Nonetheless, there are a few recommendations that will result in optimum operation.

ATTENTION

RAISE AND LOWER LID SLOWLY TO PREVENT
FROST BUILD-UP AND DAMAGE TO LINER
MANIPULER LENTIEMENT LE COUVERCLE POUR
ÉVITER L'ACCUMULATION DE GIVRE ET
ENDOMMAGER LE LINER.

- Pull the freezer lid up very slowly when accessing the freezer's storage space. This will allow air inside the storage space to remain stratified and maintain high visibility within the sample space. Pulling the freezer lid and cork out quickly will disrupt the air inside and cause warm moist air to be drawn in. This results in fog which obscures the view into the sample storage area. Please reference warning label (shown above) on the exterior of freezer's neck.
- Return racks to the freezer sample storage area as quickly as possible. This maintains the "cold chain of custody," ensuring the samples never become warm.
- Reinstall the freezer lid as soon as possible. The gaskets on the freezer's lid and neck opening are designed to maintain a nearly airtight seal when the freezer lid is properly in place. This prevents moisture from entering the Fusion and reduces ice and frost build up on internal surfaces.
- Make sure that the lid is properly placed onto the neck. This can be achieved by aligning the lid lock through hole with the locking tab mounted on the side of the neck. This assures that the lid's magnetic strip is properly placed/aligned with the lid sensor. Ensure that the lid gasket is aligned on the top of the neck gasket located on the freezer's neck by centering the lid within the neck.
- No more than two (2), 13-2 room temperature ($\approx 20^{\circ}\text{C}$) racks with boxes (no samples) can be added to the Fusion freezer at any time. Adding more than two racks with boxes may cause the nitrogen pressure to exceed the allowed limit and vent from the pressurized cryogen storage vessel. If nitrogen venting frequently occurs, additional LN_2 will be required to refill the cryogen storage vessel.
- To maximize Fusion storage capacity, storage racks need to be arranged in an optimum fashion. Mini racks may be inserted in unoccupied spaces. See Setup section 3.1 as reference for the ideal arrangement of standard racks.

CAUTION: The user should never operate the Fusion freezer without the Android running the Fusion application and should never exit the application during operation. 

4.2 Temperature Alarm Setpoint Change procedure

The “Freezer Temp” displayed is the air temperature measured at or near the top of sample storage area. To change the Fusion freezer’s temperature alarm setpoint:

1. Tap “Freezer temp” on the “Levels” screen.

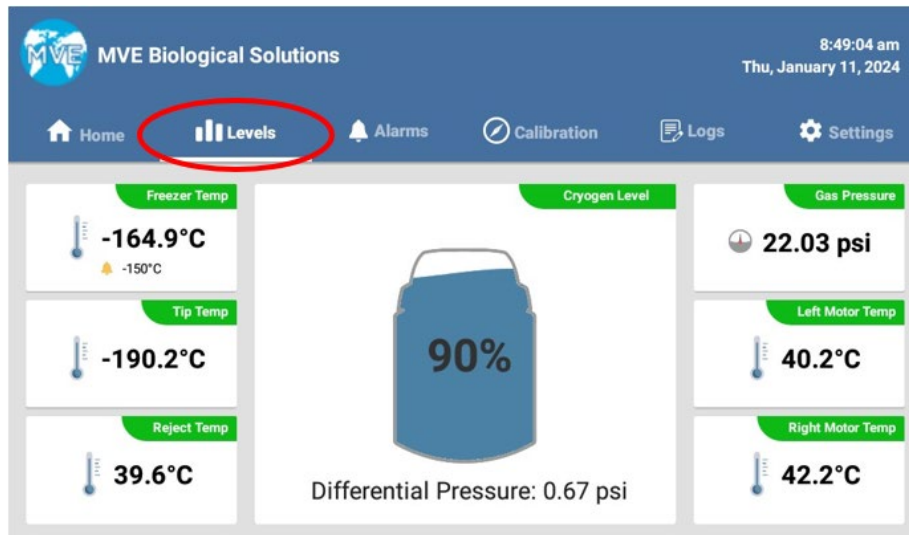

2. Tap the “+” icon to increase or the “-” icon to decrease the freezer alarm setpoint temperature. Acceptable alarm setpoint must be between 0°C and -160°C.

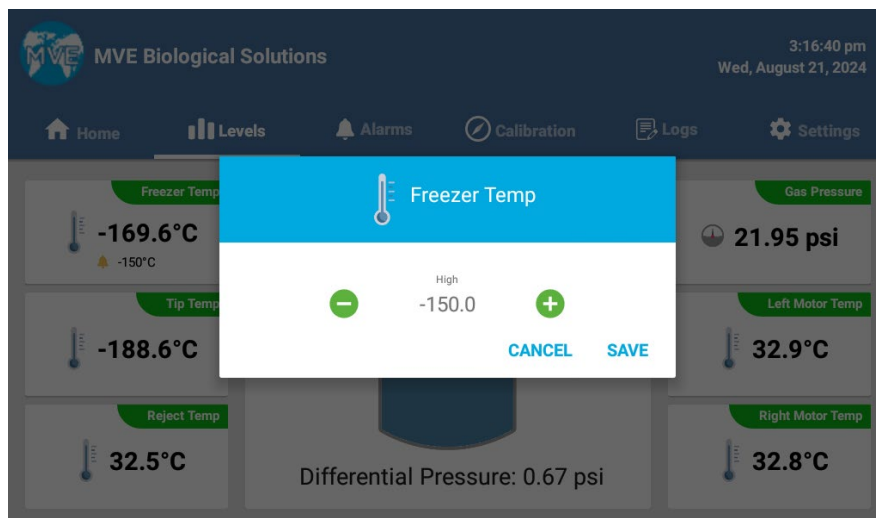

3. Tap “SAVE” to register the new setpoint and return to previous screen. Tap “CANCEL” to retain the current setpoint.

4.3 Time and Date setting

The displayed date and time are altered from the Android home screen settings menu.



1. From the bottom edge of the screen swipe up to reveal the Android application bar.
2. Tap the Android home icon (circle) on the center of the application bar.

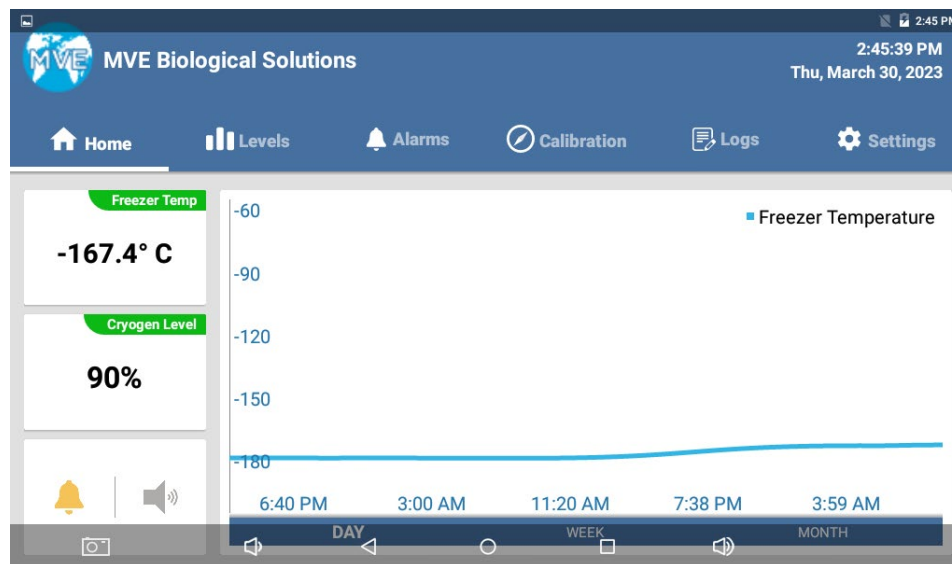

3. Tap  Settings icon.
4. Scroll up or down menu to "Date & time".
5. Tap to set date and time.
6. Save settings.

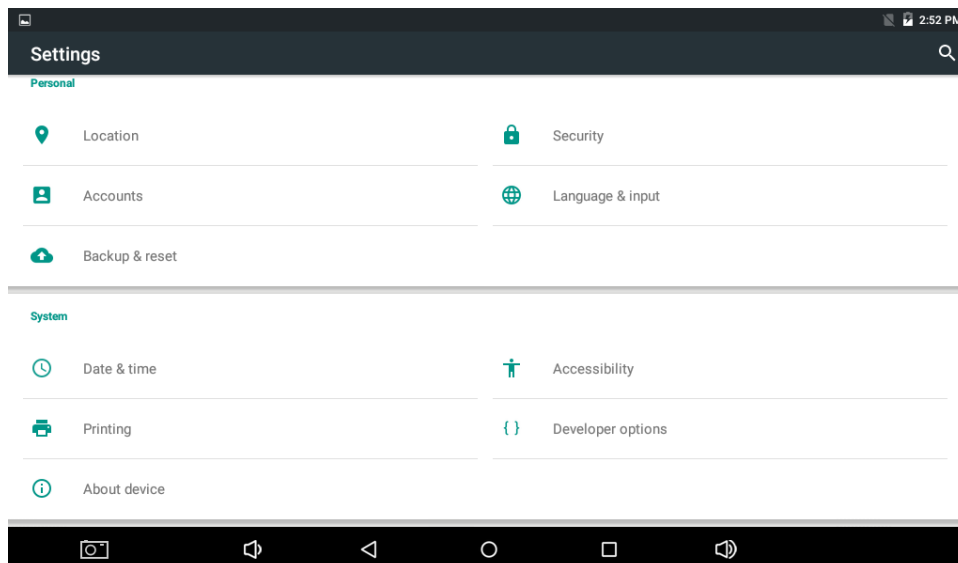

7. When complete, tap the Android home icon (circle) on the center of the application bar.

8. Tap the MVE Fusion icon



to return to the Fusion monitoring system.

4.4 Log Data Transfer

1. Insert a USB memory drive into the Fusion’s USB port below the LCD touchscreen.
2. On the GUI, the confirmation message shown below should appear.



1. Navigate to the “Logs” screen.
2. Tap the “USB Storage.”

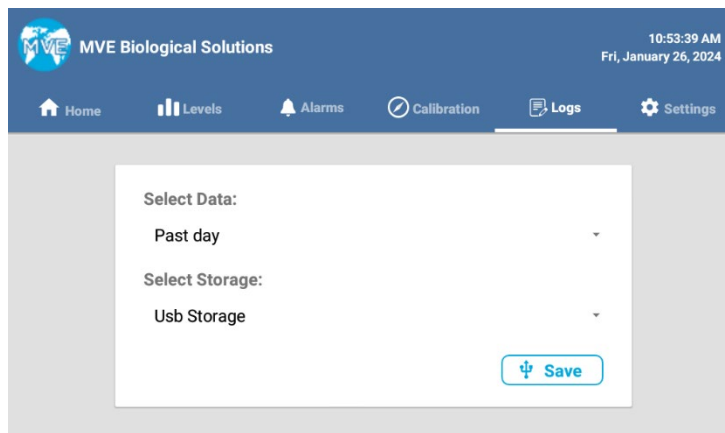

3. Tap the desired duration under “Select Data”.

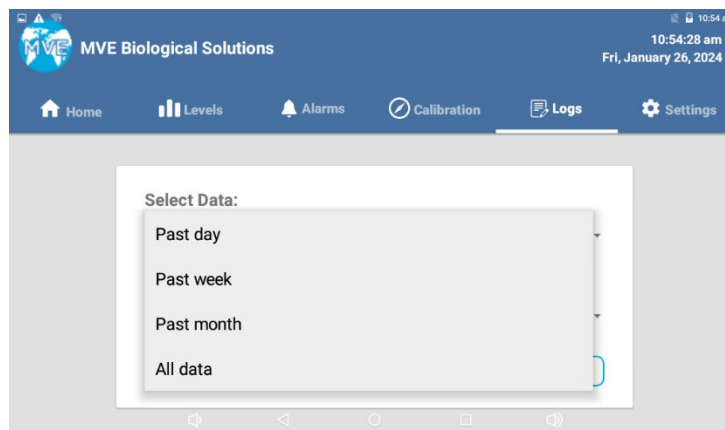

4. Tap “Save”

5. Tap the password field.

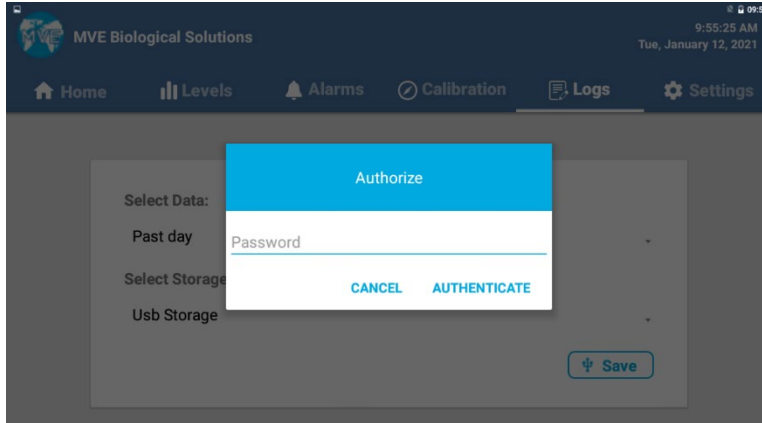

6. Enter the password - Fusion01
7. Tap the check mark “✓” icon on keyboard.

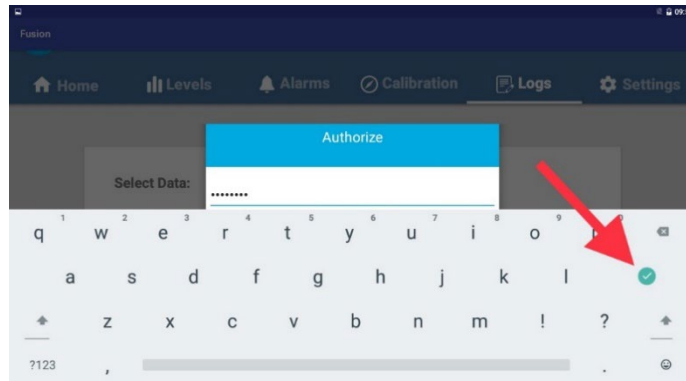

8. Tap “AUTHENTICATE”.

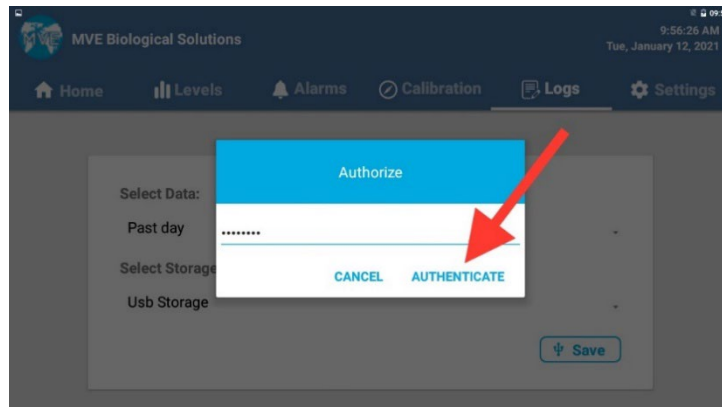

9. A “Success! File saved to disk” message will display indicating that the data has been transferred.
10. Remove the USB memory drive from the Fusion USB port.
11. Insert the USB memory drive into computer to review the saved file.

The Log file is a .csv (comma-separated values) text file, with the filename in the format FusionLog_yyyy-mm-dd-hh-mm-ss.csv.

**Table 4: Sample Log File**

Date	Freezer Temp (°C)	LN ₂ Level (%)	Differential Pressure (psi)	Tip Temperature (°C)	Gas Pressure	Reject Temperature (°C)	Left Motor Temperature (°C)	Right Motor Temperature (°C)	Alarms
9/19/2022 7:00	-164.1	100	0.72	-188.2	22.62	37.6	36.6	35.7	
9/19/2022 8:00	-164.2	100	0.73	-187	23.01	34.7	34.5	33.9	
9/19/2022 9:00	-164.2	100	0.72	-188.2	21.97	37.1	34.7	35	
9/19/2022 10:00	-164.1	100	0.72	-188.1	22.05	37	34.7	35.1	
9/19/2022 11:00	-164.1	100	0.72	-188.2	21.91	37.7	35.2	35.4	
9/19/2022 12:00	-164.1	100	0.72	-188	21.99	37.4	34.7	35	

4.5 Settings

Settings allows the user to change the display language, password, reset password, access the Admin console, view the Open source Licenses, and view the About menu.

4.5.1 Change Language settings

Select Change Language to change the displayed language. Options include English, German, Italian, Portuguese, Spanish and French.

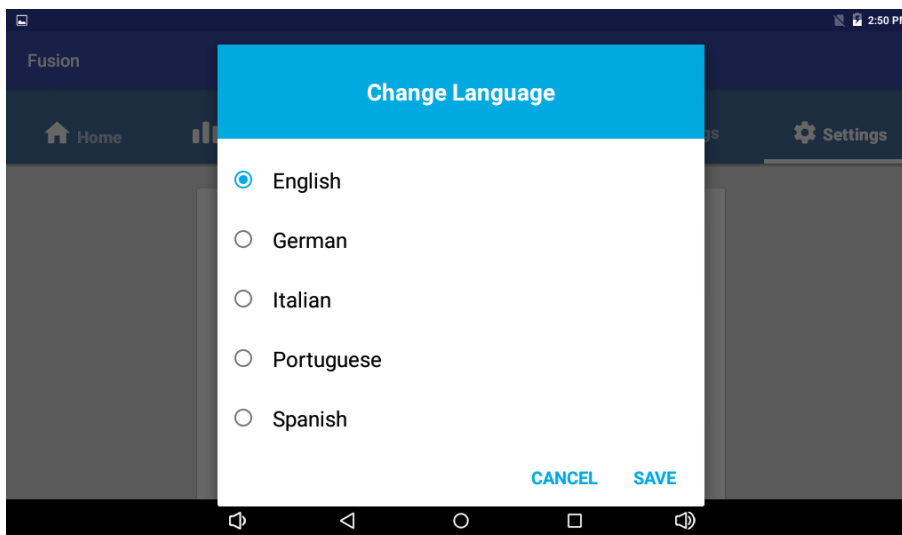

4.5.2 Change password

The Fusion's default password: Fusion01

1. Tap "Change password"
2. Enter the current password in "Current Password" field.
3. Enter a new password in "New Password" field.
4. Re-enter the new password in "Verify New Password" field.
5. Tap "Update".

6. A message indicating that the password change was successfully will appear. An error message will display if the password was not changed.

4.5.3 Password reset

1. Tap “Reset Password”.
2. A message will appear “Are you sure?”.
3. Tap “Yes” to confirm changing to the factory default password “Fusion01.”

4.5.4 Admin Console

The Admin Console sets the Fusion serial number and cryocooler serial number and is entered at the factory.

4.6 Refill/Top-Off Procedure

NOTE: The transfer hose should be warm and purged prior to connecting to the Fusion to prevent water/ice contamination.

NOTE: The recommended LN₂ supply pressure is 22 - 35 psig (1.52 - 2.41 bar).

NOTE: To perform a LN₂ refill/top off, the gas pressure as displayed on the GUI should indicate the LN₂ pressure is at or near atmospheric pressure. This can be achieved by opening the Fusion’s vent valve. Ensure both isolation valves are open with the GUI screen operating to verify the drop in pressure that will occur when the gaseous nitrogen is vented from the storage vessel via the vent valve.

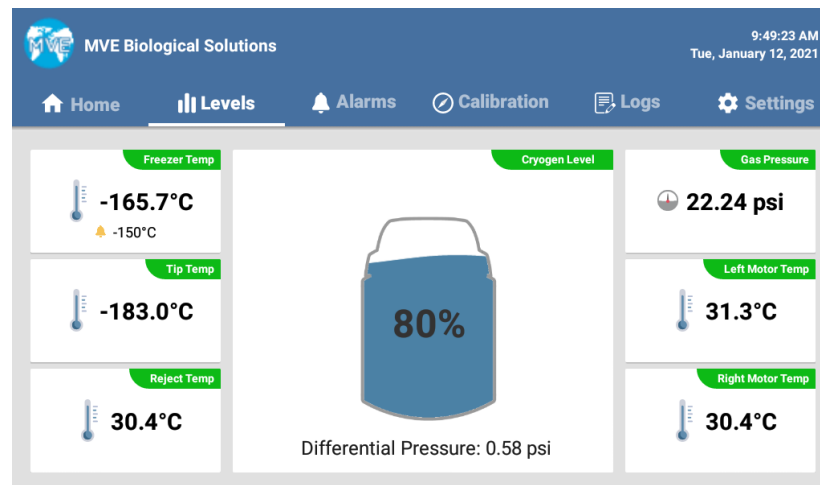



1. MVE supplies one transfer hose with a pressure relief valve attached to a “candy cane”. Connect the “candy cane” end of that hose to the LN₂ supply tank, with the “candy cane” oriented in the vertical position so the pressure relief valve vents LN₂ downwards. Be sure to purge the transfer hose before connecting to the Fusion’s inlet fill valve.
2. Connect the LN₂ supply tank to the MVE Fusion’s fill valve.



Figure 22: Transfer hose connection

3. Open the vent valve to reduce the gas pressure within the Fusion’s cryogenic storage vessel.

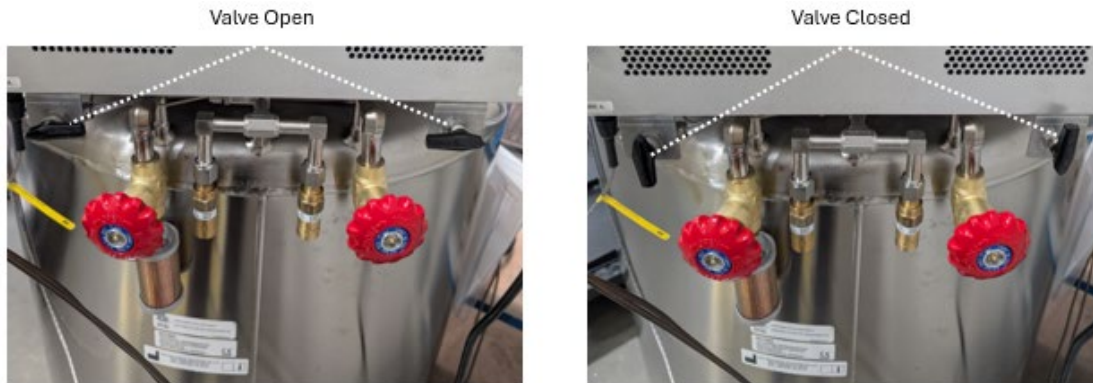

Figure 23: Isolation valve: Both valves in the open, horizontal position (left), both valves in the closed, vertical position (right)

4. Close both isolation valves located under the liquefier, one on each side.
5. Remove the freezer lid or position it in a tilted position within the neck.
Photo here
6. Open the liquid supply valve on the 230-liter LN₂ supply tank.
7. Open the Fusion’s LN₂ fill valve by turning valve counterclockwise.
8. Both fill and vent valves should remain open until the Fusion’s pressurized cryogen storage vessel is refilled/topped off.
9. When liquid begins to flow from the vent valve, close the vent valve.
10. Close the LN₂ fill valve.
11. Close the LN₂ supply tank’s liquid valve.
12. Open both isolation valves located under the liquefier, one on each side.



13. Verify that the LN₂ Level displayed on the GUI is 90% to 100%.

5. Preventative Maintenance Schedule

Regular and proper maintenance of your Fusion freezer is the best way to protect your investment. It is essential that you have your equipment serviced as scheduled to retain optimum performance and reliability, which will reward you with safer, less problematic product performance over time.

Proper care and handling on a day-to-day basis is extremely important to ensure safe and efficient operation.

Service at the recommended service intervals is mandatory to keep your product's warranty in effect. Any services and/or repairs done by any unauthorized personnel may result in reduced performance of the Fusion freezer and is not recommended.

NOTE: This is the MVE recommended preventative maintenance schedule. MVE Distributors may have a more comprehensive maintenance/service plan.

Table 5: Preventative Maintenance Schedule

Activity	Monthly	6 Months	12 Months	24 Months	60 Months
Lid Inspection	X				
Pressure Relief Valve Inspection		X			
Globe Valve (Inlet/Vent) Inspection		X			
Lid Thaw (As necessary, humidity greater than 50%)		X			
Lid Gasket Inspection (As necessary, humidity greater than 50%)		X			
Dewar Neck Gasket Inspection (As necessary, humidity greater than 50%)		X			
Neck Inspection (Remove ice buildup as necessary) ¹		X			
Step Assembly Inspection (Replace as necessary)		X			
Lid Gasket Replace (As necessary, humidity greater than 50%)				X	
Clear vinyl tube inspection (Check for leaks)				X	
Fan Inspection (Replace If Noisy/Rattling) and dust removal from within Liquefier				X	
Check Backup Battery Voltage				X	
Backup Batteries Replacement					X

NOTE 1: Check freezer at a five 5-year interval and thaw only if ice builds up enough to impede the proper rack insertion, impedes access and retrieval of samples, and or freezer lid closure.

6. Alarms (Notifications)

Contact authorized MVE Distributor or MVE Technical Service for any sustained alarms.

6.1 Alarms

MVE’s Fusion freezer notifies the user when the system is operating outside of any predefined parameters. Alarm notifications contain a message that includes the alarm type, date and time. If enabled, the alarm buzzer will sound.

Press “DISMISS” to stop the alarm from being displayed. If an alarm condition is not resolved, the alarm will continue to notify the user.

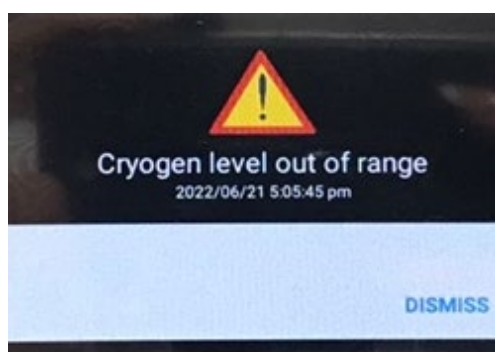

Figure 24: Alarm Notification

MVE’s Fusion freezer comes from the factory with preset alarm parameter ranges for monitoring system conditions. Only the freezer alarm temperature setpoint can be altered by the user.

Table 6: Preset Alarm Temperatures

Parameters	Alarm Set Points		Define by
	LOW	HIGH	
Freezer Temperature Alarm* (°C)	No limit	-150	User can adjust this value to be between 0 and -160°C
Tip Temperature Alarm (°C)	No limit	-170	MVE
Reject Temperature (°C)	No limit	60	MVE
Left Motor Temperature (°C)	No limit	60	MVE
Right Motor Temperature (°C)	No limit	60	MVE
Cryogen Level** (%)	40	N/A	MVE
Liquid Pressure (PSIG)	15	45	MVE

*Freezer temperature measured at a height representing the top of a standard 13-2 storage rack

**cryogen level alarm occurs at or below 40%



6.2 Alarms and Descriptions

When an alarm message is encountered it will be displayed on the Fusion's GUI. A description of the Fusion's alarms are provided below.

Table 7: Alarm Descriptions

Alarm Display	Description
TIP TEMP FAULT	Issue with thermocouple located on the QDRIVE Cryocooler's cold tip.
REJECTTEMPFAULT	Issue with thermocouple located on the QDRIVE Cryocooler's heat rejection core.
MOTOR TEMP L FAULT	Issue with thermocouple located on the QDRIVE Cryocooler's left motor.
MOTOR TEMP R FAULT	Issue with thermocouple located on the QDRIVE Cryocooler's right motor.
FREEZER TEMP OPEN	Issue with the RTD connection.
MOTOR R OUT OF RANGE	QDRIVE Cryocooler right motor temperature is out of the allowable set points.
MOTOR L OUT OF RANGE	QDRIVE Cryocooler left motor temperature is out of the allowable set points.
TIPTEMPOUTOFRANGE	QDRIVE Cryocooler cold tip temperature is out of the allowable set points.
REJECT T OUT OFRANGE	QDRIVE Cryocooler reject temperature is out of the allowable set points.
FREEZER TEMPOUTOF RANGE	RTD temperature out of the allowable set points.
FREEZER TEMP SHORT	Issue with the Fusion's RTD.
VIBRATION FAULT	QDRIVE Cryocooler vibration level is out of the allowable set point.
LID OPEN	The Fusion lid has been off for more than 5 minutes.
BATTERY LOW	Backup battery voltage is low.
LN ₂ OUT OF RANGE	Cryogen (LN ₂) level within the storage vessel is below the allowable set point.
GAS PRESS OUT OF RANGE	Gas Pressure within the pressure vessel is above the allowable set point.
VFD HARDWARE FAULT	Issue with the Fusion's electronics.
VFD OVER CURRENT	Issue with the Fusion's electronics.
VFD OVER TEMPERATURE	Fusion electronics temperature is above the allowable set point.
ELECTRONICS FAULT	Issue with the Fusion's electronics.

CAUTION: If any alarms are sustained, please contact your authorized MVE Distributor or MVE Technical Service.

6.3 Global Alarm Dry Contacts

The MVE Fusion offers Global Alarm dry contacts that switch from normally open or normally closed conditions when an alarm condition occurs. This indicates when there is an alarm present but does not indicate the specific alarm. The Global Alarm system consists of a three-wire latching contact. Normally Open (NO), Normally Closed (NC), and a Common (COM). Once an alarm activates, the Global Alarm Latching Contacts change state as described below:

- NO = Contact is normally open during "no alarm"; when the Fusion alarms this contact closes.
- NC = Contact is normally closed during the "no alarm"; when the Fusion alarms this contact opens.
- COM = Common contact used in conjunction with NO or NC to complete circuit.



Figure 25: Global contacts (Dry contacts)

7. Troubleshooting

CAUTION: This information is included primarily for reference. MVE recommends any advance troubleshooting be performed by an authorized MVE distributor or representative. Contact MVE Technical service with any questions.



When an alarm notification is encountered, the GUI will display the alarm type.

1. For system alarms, tap “Dismiss” on the touchscreen.
2. If the alarm persists, proceed with troubleshooting.
3. Contact an authorized MVE Distributor or MVE Technical Service.

Table 8: Troubleshooting

ALARM/SYMPTOM	POSSIBLE CAUSES	ACTION /TROUBLESHOOTING TIPS
Freezer Temp Alarm / Out of Range	High Temp Alarm indicates warmer than the users set point (default set point is -150°C)	Tap “Dismiss” alarm and verify if the alarm continues. If the alarm clears, the alarm condition has been resolved.
		Verify the temperature high alarm set point.
		The temperature probe is not fully inserted into sensor tube.
		The Fusion was first filled and/or recently refilled/topped off. Allow the Fusion to equalize/achieve steady state operation.
		Warm inventory was recently inserted. Allow the Fusion to equalize/achieve steady state operation.
		Ambient air intrusion. Ensure correct lid placement and that the RTD ports are sealed with silicone.



ALARM/SYMPTOM	POSSIBLE CAUSES	ACTION /TROUBLESHOOTING TIPS
		Verify QDRIVE cryocooler operation.
	RTD Issue	Tap "Dismiss" alarm and verify if the alarm continues. If the alarm clears, the alarm condition has been resolved.
		Measure the temperature probe's resistance value. It should be approximately 1080 Ohms at 23°C and 1000 ohm at 0°C. If it is out of specification, replace RTD.
		Verify a good temperature sensor connection at liquefier connector.
		Verify that the RTD's internal wires are firmly connected to control board. This requires removal of the liquefier shroud.
	Warm air leaking into the freezer	Check the freezer's lid position, lid gasket, and Dewar's neck gasket.
		The RTD may not be properly sealed at the temperature probe sensor tube under the liquefier. Seal port with silicone if needed.
		Verify that the plug inserted in the secondary temperature sensor port (if not being used) under the liquefier. If using a third-party probe, verify sealing. Seal the port with silicone if needed.
	Out of the set range	Verify the freezer's temperature alarm set points.
		Perform RTD temperature calibration procedure.
Lid Open Alarm	Lid is not positioned in the correct orientation with respect to magnetic switch.	Tap "Dismiss" alarm and verify if the alarm continues. If the alarm clears, the alarm condition has been resolved.
		Reposition the freezer's lid with respect to magnetic switch (front, bottom, center of the liquefier's face).
	Lid has been removed for more than 5 min.	Install freezer lid.
	Lid's magnetic strip not functioning.	Replace the lid with an OEM freezer lid.



ALARM/SYMPTOM	POSSIBLE CAUSES	ACTION /TROUBLESHOOTING TIPS
	Incorrect lid being used.	Replace the lid with an OEM freezer lid.
Lid is stuck closed, cannot be opened.	The temperature inside the Fusion's sample space has significantly decreased while the lid was in place, resulting in a partial vacuum being pulled holding the lid in place.	Open the vacuum relief valve on the lid. If the valve is not present or vacuum persists, insert a plastic spudger (or the like) under the Dewar's neck gasket and attempt to lift the neck gasket upward, which should release the lid. DO NOT ATTEMPT WITH A METAL SCREWDRIVER or METALLIC HANDTOOLS.
	Possible moisture intrusion has created ice around the lid's cork.	Remove the ice between the cork and the freezer's neck area; remove the freezer's lid. The freezer's lid may have to be replaced due to damage. If unable to dislodge, please contact an authorized MVE Distributor or MVE Technical Service. DO NOT ATTEMPT ICE REMOVAL WITH A METAL SCREWDRIVER or METALLIC HANDTOOLS.
Tip Temperature Alarm / Out of range	Cold Tip Temperature is warmer than -170°C.	Tap "Dismiss" alarm and verify if the alarm continues. If the alarm clears, the alarm condition has been resolved.
		Fusion was first filled or recently refilled/topped off. Allow the Fusion to equalize/achieve steady state operation.
		Verify the QDRIVE cryocooler is operating.
		Verify and check the QDRIVE cryocooler's fuse.
		Check/Verify the A/C power source, 100-230 V, 50-60Hz. MVE recommends the use of a dedicated 15-amp circuit breaker outlet for operating one Fusion.
		MVE recommends the use of a dedicated 15-amp circuit breaker outlet for operating one Fusion.
		The thermocouple cable is not connected or loose. Verify the thermocouple's connection at the control board.
	Thermocouple issue.	Verify QDRIVE cryocooler is operating.
Verify and check the QDRIVE cryocooler fuse.		



ALARM/SYMPTOM	POSSIBLE CAUSES	ACTION /TROUBLESHOOTING TIPS
		Power the Fusion off/on and verify thermocouple performance.
		Tap “Dismiss” alarm and verify if the alarm continues. If the alarm clears, the alarm condition has been resolved.
Reject Temperature Alarm / Out of range	Rejection core temperature too high	Verify the Liquefier’s shroud is closed and sealed.
		Verify both fans are operational.
		Verify the room’s ambient temperature is within operating specifications (65°F – 81°F, 18°C – 27°C). If it is too hot, reject and motor temperatures will run hotter.
		Verify the room’s environmental humidity is within operating specifications (below 50%).
	Thermocouple issues	The thermocouple wires not connected or loose. Verify the connection at the control board.
		Power the Fusion off/on and verify thermocouple operation.
Left / Right Motor Temperature Alarm	Motor temperature too high	Verify the Liquefier’s shroud is closed and sealed.
		Tap “Dismiss” alarm and verify if the alarm continues. If the alarm clears, the alarm condition has been resolved.
		Verify both fans are operational.
Left / Right Motor Temperature Open	Motor temperature too high	Verify the Liquefier’s shroud is closed and sealed.
		Verify both fans are operational.
		Verify the ambient temperature is within operating specifications.
		Verify the environmental humidity conditions are within operating specifications.



ALARM/SYMPTOM	POSSIBLE CAUSES	ACTION /TROUBLESHOOTING TIPS
	Thermocouple issues	Visually verify the thermocouple(s) are attached to the motors through the back opening.
		Verify the thermocouples are properly seated in their respective screw in terminal.
Cryogen Out of Range	Cryogen level below 40%	System may have a leak. Leak check plumbing joints.
		Check the isolation valves for leaks. Leak check valve assembly/joints
		Check and inspect clear vinyl tubes for any leaks/frost build up at control board and secure with zip-ties.
		Verify the isolation valves are open.
		Excessive warm inventory was recently inserted. Allow Fusion to equalize/achieve steady state operation, then refill as needed.
Gas Pressure Out of Range	Gas pressure is higher than 45psi (2.7bar).	Freezer® lid left off. Reinstall and align lid.
		Tap "Dismiss" alarm and verify if the alarm continues. If the alarm clears, the alarm condition has been resolved.
	Gas pressure continues to increase and is venting.	One or more warm racks have been inserted. Allow system to stabilize.
		Warm air intrusion, check RTD tubes to ensure they are properly sealed.
Battery backup voltage is low	Battery backup voltage is low.	Check for leaks in plumbing manifold. Check for leaks at relief valve(s).
		Fusion was first filled or recently refilled/topped off. Allow to stabilize.
		Warm air intrusion, check RTD tubes to ensure they are properly sealed.



ALARM/SYMPTOM	POSSIBLE CAUSES	ACTION /TROUBLESHOOTING TIPS
		<p>Fusion was first filled or recently refilled/topped off. Allow to stabilize.</p> <p>Verify the QDRIVE cryocooler is operating.</p> <p>Verify the A/C line voltage meets power specifications.</p> <hr/> <p>Tap "Dismiss" alarm and verify if the alarm continues. If the alarm clears, the alarm condition has been resolved.</p> <hr/> <p>Verify the AC power source. Tap, "Dismiss" alarm and verify if the alarm continues. If the alarm clears, the alarm condition has been resolved.</p> <hr/> <p>Verify if the backup battery switch is in the on position.</p>
<p>Battery backup voltage is low</p> <p>System Shutdown</p>	<p>Battery backup voltage is low.</p> <p>Possible input voltage out of operable range exceeded.</p>	<p>Check if the battery cable is firmly connected to the control board.</p> <hr/> <p>Check the inline fuse located inside the battery backup assembly.</p> <hr/> <p>Measure the backup battery with voltmeter. Replace as needed.</p> <hr/> <p>Restart the Fusion and verify.</p> <hr/> <p>Verify the A/C line voltage meets the specified power specifications.</p>
<p>System Shutdown</p> <p>Electronics over temperature.</p>	<p>Possible input voltage out of operable range.</p> <p>VFD exceeds allowable temperature range</p>	<p>If system remains in a shutdown state for more than 3 days, add 20 to 30 liters of LN₂ to the Dewar sample storage area until root cause is resolved.</p> <hr/> <p>Verify the cooling fans are operating.</p> <hr/> <p>Verify the motor and reject thermocouples are properly connected to the control board.</p> <hr/> <p>Verify the motor and reject thermocouples are properly adhered to the PWG and rejection core block.</p> <hr/> <p>Verify the QDRIVE cryocooler is operating. If the system remains in shutdown state for more than 3 days, add 20 to 30 liters of LN₂ to the Dewar sample storage area until resolved.</p>



ALARM/SYMPTOM	POSSIBLE CAUSES	ACTION /TROUBLESHOOTING TIPS
		Tap “Dismiss” alarm and verify if the alarm continues. If the alarm clears, the alarm condition has been resolved.
		Swipe touchscreen to refresh data. Tap “Dismiss” alarm and verify if the alarm continues. If the alarm clears, the alarm condition has been resolved.
		Tap “Dismiss” alarm and verify if alarm continues. If alarm clears, alarm condition has been resolved.
Vibration Fault	Vibration sensor was triggered.	Tap “Dismiss” alarm and verify if the alarm continues. If the alarm clears, the alarm condition has been resolved.
	PRV actuated	Tap “Dismiss” alarm and verify if the alarm continues. If the alarm clears, the alarm condition has been resolved.
Vibration Fault	Freezer was moved.	Tap “Dismiss” alarm and verify if the alarm continues. If the alarm clears, the alarm condition has been resolved.
	External force against freezer induced vibration against freezer	Swipe touchscreen to refresh data. Tap “Dismiss” alarm and verify if the alarm continues.
	Freezer was moved.	Restart the Fusion by turning off both the Backup Battery and Power switches in the stated order, wait approximately 15 seconds, then power back on by turning on the mains power switch then the backup battery switch.
LCD touchscreen is black	LCD may be in daydream mode	Restart the Fusion by turn off both the backup battery and the power switches in the stated order, wait approximately 15 seconds, then power back on by turning on the mains power switch then the backup battery switch. Contact MVE technical service.
	LCD may be in sleep mode.	Restart Fusion by turning off both Backup Battery and Power switches in the stated order, wait approximately 15 seconds, then power back on by turning on mains power switch then the backup battery switch. Contact MVE technical service



ALARM/SYMPTOM	POSSIBLE CAUSES	ACTION /TROUBLESHOOTING TIPS
Electronic Fault	Possible input voltage exceeded, Electronics over temperature	Restart the Fusion by turn off both Backup Battery and Power switches in the stated order, wait approximately 15 seconds, then power back on by turning on the mains power switch then the backup battery switch.
	LCD may be in sleep mode.	Check/Verify the A/C source, 100-230 V, 50-60Hz.

8. Maintenance Instruction

WARNING: Do not modify this equipment without the authorization of MVE.



Figure 26: Front Panel



Figure 27: Back Panel Connections Fusion 800 Series

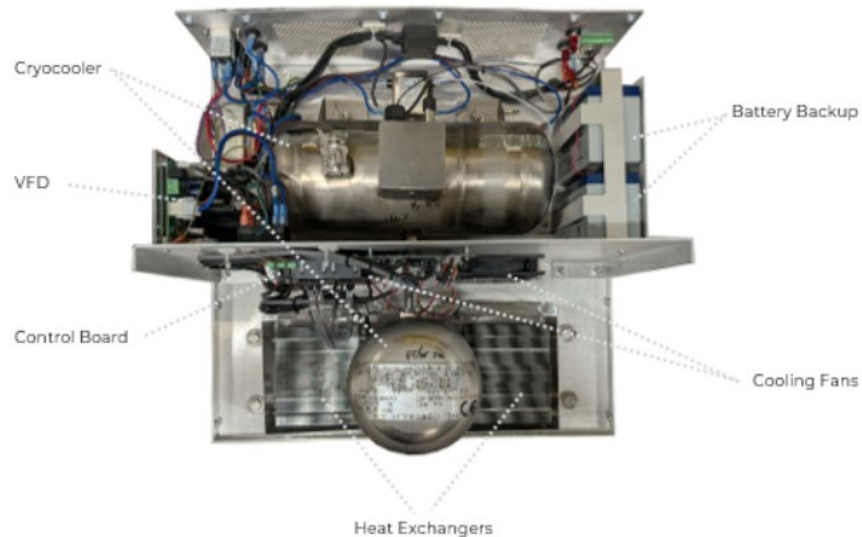

Figure 28: Fusion® Internal Components

8.1 Liquefier shroud removal

Several maintenance operations require removal of the Fusion's liquefier shroud to access its components.

Required tools:

- 5/32 in (4 mm) Allen wrench

1. Turn off the battery backup “BB” switch followed by the mains “main” power switch.





2. Unplug the Fusion's power cord from the power source or outlet.
3. Use the 5/32 in Allen wrench to remove the 28 screws on the metal liquefier shroud.



4. Carefully lift the liquefier shroud and unplug the communication and power connectors to disconnect the liquefier shroud from the control board. Refer to the PCBA photo below to locate the LCD power and LCD Comm connectors. **CAUTION:** Do not pull on or damage the wire harnesses inside Liquefier. 
5. Carefully lift and remove the liquefier shroud off the Fusion. Store the Liquefier shroud safely until it is ready to be reinstalled.

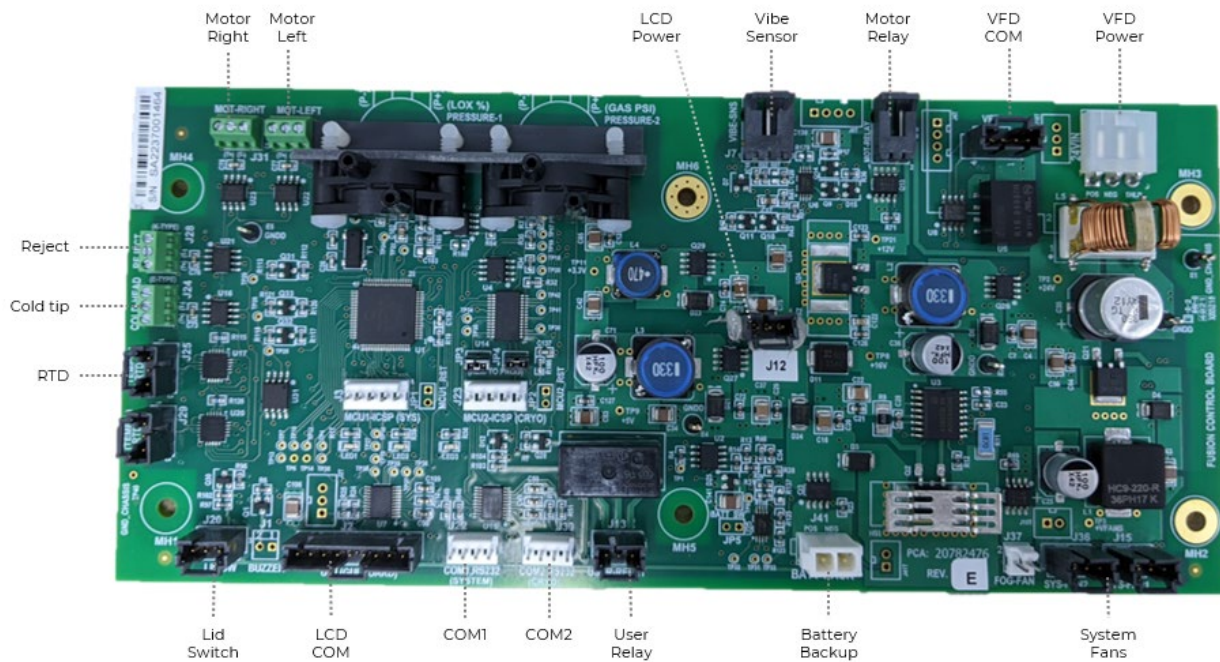





8.2 Safety relief valves and global valves inspection

Using a soap solution (snoop) on plumbing valves and components, visually inspect for leaks. Repair or replace component(s) if bubbles are observed.

CAUTION: Ensure that the pressure vessel has vented to atmospheric pressure before removing the relief valve(s). Note, it may be necessary to refill/top off the pressurized cryogen storage vessel. 

Required tools:

- Soap solution (snoop)
- Teflon tape



1. Verify that the Fill valve is closed.
2. Open Vent valve until the gas pressure in the Fusion's pressurized cryogen storage vessel reaches atmospheric pressure (gauge pressure approximately 0 psig). 
3. If equipped with a relief valve deflector, loosen the deflector clamp and slide off the deflector.
4. Loosen the relief valve and remove it from the plumbing assembly. Be sure to support the attachment tube with the wrench to prevent damage from twisting the assembly. 
5. Reapply new Teflon tape on new pressure relief valve threads. Install the new pressure relief valves. Ensure relief valve is rated to 50 PSI (3.4 bar).

CAUTION: Installing a relief valve having a different pressure rating other than the 50 psi could prevent proper operation and lead to a dangerous over pressure condition. This will void any warranty. 

8.3 Lid, Lid thaw, gasket, and freezer neck gasket inspection

Required tools:

- None

1. Remove the lid slowly from the freezer.
2. It is recommended that the freezer opening be covered with a spare lid or in another non-airtight manner to prevent moisture from entering the storage space and to minimize the top box temperature change while the lid is open. 
3. Visually inspect the lid, the lid's gasket and neck gasket for ice accumulation and damage. If any of the above parts are damaged, replace the component. 
4. Verify that the Dewar neck gasket is seated on the neck properly.
5. If ice accumulation is present on the lid allow the lid to thaw. Allow the freezer lid to sit at room temperature for approximately 30 minutes or until the ice has melted.

NOTE: The Fusion's lid open alarm will sound. Press the alarm mute button to temporarily silence the alarm. 

6. Once thawed, thoroughly dry the freezer lid, cork, and liner.
7. Inspect the lid for damage and replace if necessary.

8. Wipe down the neck to remove ice and moisture.

NOTE: Do not attempt ice removal with a metal screwdriver or metallic hand tools.



9. Reinstall lid on freezer.

8.4 Fusion neck gasket replacement

1. Slowly lift the lid to prevent frost build up and damage to the cork and set aside.
2. Remove neck gasket.
3. Clean and remove ice and moisture that may have built up around neck gasket area.
4. Install the new neck gasket.

8.5 Clear vinyl tube inspection

SAFETY NOTE: Unplug the Fusion's power cord from the power source or wall outlet and carefully open the liquefier shroud to access its internal components.



WARNING: Only authorized MVE Distributor or Service Technician should carry out this activity.

Required tools:

- Soap solution (snoop)

1. Apply soap solution on the isolation valve connections located underneath the liquefier to visually inspect for leaks at tube connections.
2. Touch and verify that the vinyl tubes connected to the control board are secure.

8.6 Dust Removal

WARNING: Only an authorized MVE Distributor or Service Technician should carry out this activity.



1. Switch off the battery backup switch then the main power switch.
2. Unplug the Fusion's power cord from the power source or wall outlet.
3. Remove the liquefier shroud per Section 8.1.
4. Inspect and clean with compressed air to remove dust/debris from the QDRIVE cryocooler's heat pipe fins and the two cooling fans within liquefier assembly every 24 months.
5. If necessary, blow dust and debris out of the interior of the cabinet with compressed air to clean the cabinet.
6. Take a cloth and wipe away dust and debris off the two fans.
7. Reinstall the liquefier shroud.



NOTE: Depending on the Fusion's environmental operating conditions, the fans and cabinet cleaning may need to be performed more frequently to ensure optimal performance of the MVE Fusion freezer.



8.7 Temperature probe (RTD) replacement

1. Disconnect the temperature probe from the liquefier housing.
2. Remove the silicone sealant from the annular line.
3. Gently pull the temperature probe from annular line.
4. Verify that the new temperature probe is completely dry and free from moisture.
5. Install the new temperature probe. Ensuring that the probe is fully inserted into the annular line (approx. 22.25" inches).
6. Apply silicone to seal the annular line from moisture ingress.
7. Connect new temperature sensor to the liquefier RTD probe connector.
8. Confirm RTD correct RTD readings on GUI.

NOTE: Allow a minimum of 5 minutes for new RTD to acclimate to freezer environment.

NOTE: If the temperature sensor cannot be removed, moisture intrusion has caused ice buildup within the sensor tube. A complete freezer thaw may be necessary. See taking freezer out of service in Section 11.

8.8 Temperature Calibration

The “Calibration” screen is for calibrating the Resistance Temperature Detector (RTD). The Fusion freezer utilizes a two-point calibration measurement capability.

NOTE: The delivery of Fusion Freezer comes with a factory calibrated RTD. Replacement RTDs are not factory calibrated but can be calibrated in the field. Repeat calibration steps as necessary.

CAUTION: MVE recommends the RTD calibration be performed by an authorized MVE distributor, end user trained by the distributor and/or MVE personnel. The RTD probe must be removed from freezer to be calibrated. 

Required equipment:

- Cup of ice water
- Small, insulated Dewar (Dewar flask) with LN₂
- Fusion password: Fusion01
- Silicone sealant

NOTE: If the password is not valid, proceed to reset the password in the Settings Menu. Refer to the password reset instructions. See Settings section 4.5.

1. Navigate to Calibration Screen.

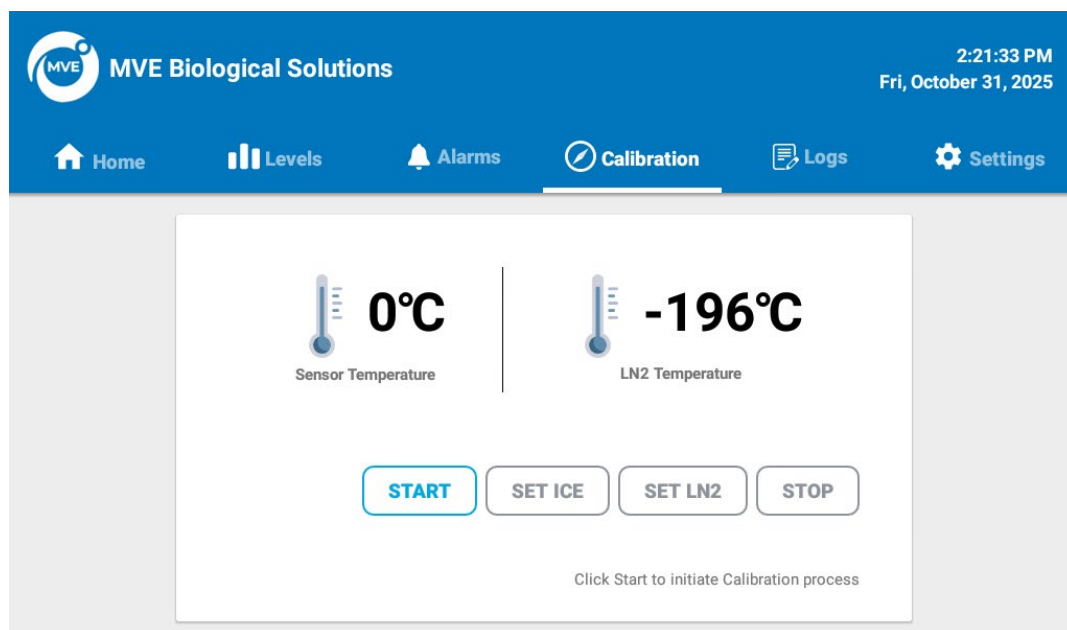

2. Tap the “START” button.

3. A password screen will appear.

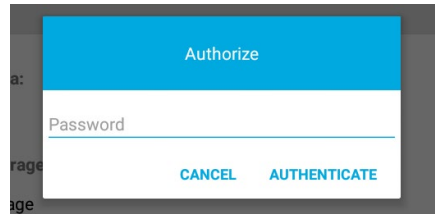

4. Tap the password field. A keyboard will appear.
5. Enter the password. **NOTE:** Passwords are case sensitive.
6. Tap the "✓" icon. The keyboard will disappear.

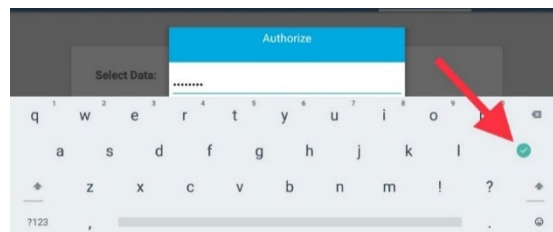

7. Tap "Authenticate".

NOTE: The calibration process may be cancelled by tapping the "Stop" button. If cancelled, a message will be displayed indicating no calibration was performed.

8. The "SET ICE" button should turn blue and the screen will change to what is shown below.

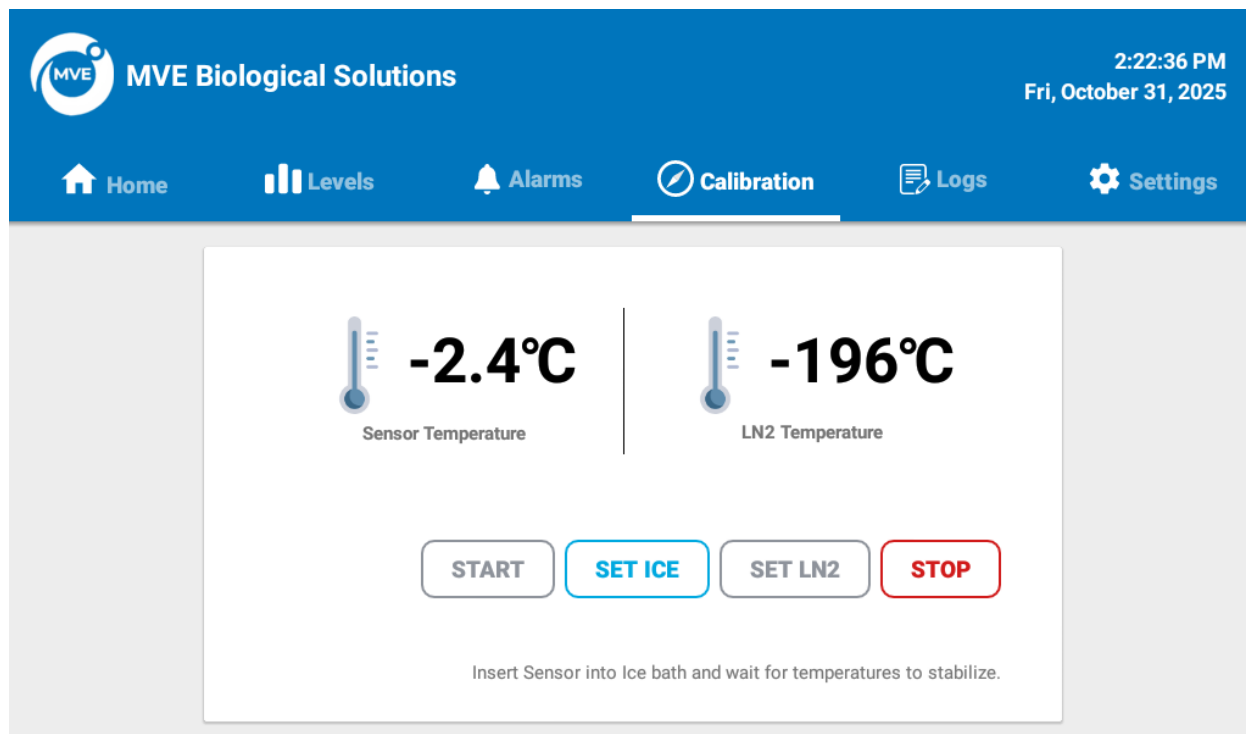

9. Remove the RTD temperature sensor from the back of the Fusion and place it into a cup of ice water. The “Sensor Temperature” on the GUI should begin to approach 0°C.
10. Once the RTD temperature in the ice bath has stabilized, press the “SET ICE” button. This will set the first calibration point. A pop up should appear stating “ICE DATA LATCHED, PLEASE SET LN₂ WHEN READY.”
11. Remove the probe from the ice bath and wipe off any excess moisture that may be present on the probe. Submerge the RTD probe into a Dewar flask filled with LN₂. 
12. Once the RTD temperature in the LN₂ has stabilized, press the “SET LN2” button to set the second calibration point. A pop up should appear stating “CALIBRATION SUCCESSFUL” and the GUI should navigate to the home screen.
13. Clean and wipe dry the RTD temperature sensor.
14. Insert the dry temperature sensor into the Fusion’s RTD sensor tube.
15. Apply silicone sealant to keep the sensor tube sealed to prevent moisture ingress during operation.

8.9 Backup Battery Inspection

1. Check the battery backup voltage (10-13 VDC) every two 2 years.
2. Replace the backup batteries every five 5 years or as needed.

SAFETY NOTE: Unplug the Fusion’s power cord from power source or outlet and carefully open the Liquefier shroud to access the components to service. Do not pull on or damage the wire harnesses inside the liquefier.



NOTE: New batteries may need to be charged for several hours before they are able to power the GUI. The software will constantly monitor, charge, and sense the



current in its battery circuit with main electrical power connected. Software will produce a trickle charge to keep the batteries fully charged.

In the event of a power loss, the backup battery will provide power to the LCD/GUI touchscreen display for a minimum of 12 hours. The GUI will start to lose functionality when the Battery Backup is not capable of providing the required DC voltage.

To test the battery backup assembly, disconnect the backup battery connection to the control board. Using a multimeter measure the voltage between the positive and negative terminals on the backup battery connector. The voltage should measure 12 to 13 VDC. If the backup battery assembly's voltage measures below 12VDC, the backup battery assembly needs to be replaced.

8.10 Battery Replacement

SAFETY NOTE: Unplug the Fusion's main power from the electrical outlet or power source and carefully open liquefier shroud to access the components before service. Do not pull on or damage the wire harnesses inside the liquefier.



NOTE: New batteries need to be charged for several hours before they are able to power the Fusion monitoring system.

1. Switch off the battery backup switch followed by the system power switch.
2. Disconnect power cord from power source or outlet.
3. Remove liquefier shroud per Section 8.1.
4. Remove the foam insert that sits over the fan and battery backup assembly.
5. Remove the four Phillips screws holding backing plate.
6. Disconnect the wiring harness and fuse.
7. Install new battery assembly.
8. Reinstall back plate, foam insert, and liquefier shroud.
9. Reconnect the Fusion freezer to a power source or outlet.
10. Switch on system power switch followed by the battery backup switch.

8.11 Fan Replacement

SAFETY NOTE: Do not pull on or damage the wire harnesses inside Liquefier.

Both fans should be replaced at the same time.

1. Switch off the battery backup switch followed by the system power switch.
2. Disconnect the power supply from its power source or outlet.
3. Remove the liquefier shroud per Section 8.1.
4. Remove the fan's screws.
5. Disconnect the fan's cables from the control board.
6. Remove the fans.
7. Install the new fans.
8. Replace the fan's screws.
9. Connect the fan's cables to the control board.
10. Reinstall liquefier shroud.
11. Connect the Fusion power cord to a power source or outlet.
12. Switch on the system power switch followed by the battery backup power switch.



Figure 29: Fan brackets

WARNING: Make sure the fans do not contact the cryocooler if applicable.



8.12 Clear Vinyl Tube Replacement

SAFETY NOTE: Unplug the Fusion's power cord from electrical power source or outlet and carefully open the liquefier shroud to access these components before service. Do not pull on or damage the wire harnesses inside Liquefier.



Isolation valve tube replacement

- MVE will supply three tubes; each will be preassembled with stainless steel Swagelok ferrules and nuts.



Figure 30: Clear Vinyl Tube Hose Replacements

- Ensure that the stainless insert is tight and does not come off.
1. Switch off the backup battery switch followed by the system power switch.
 2. Disconnect the power supply from power source or outlet.
 3. Remove liquefier shroud per Section 8.1.
 4. Use a 3 inch long 9/16 inch wrench, in order to loosen and tighten the isolation valve nuts.



5. Use another 9/16-inch wrench to hold/stabilize isolation valve in place as you loosen and tighten the isolation valve nuts. Use caution to not damage the isolation valve body.



6. Remove and replace one clear tube at a time. Run new tube through the same cutout holes underneath the metal shroud into the cryocooler assembly. The tubes will be longer than needed. Compare the length to the old tube and trim as needed.



7. Connect each tube to the control board. If the previous tube was connected to the control board with a zip tie, use a zip tie to secure the tubes connection to the control board. Replacing one tube at a time will assure connecting each tube to its

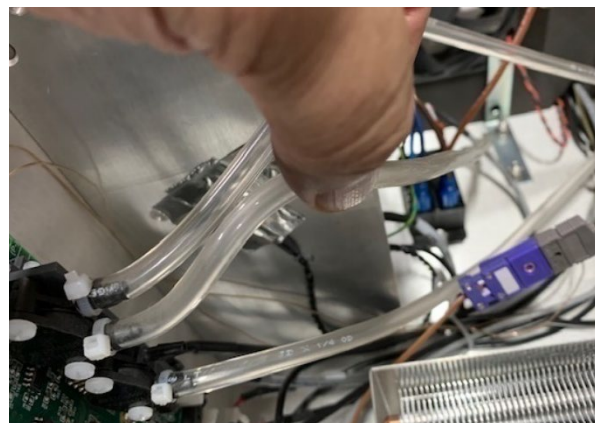
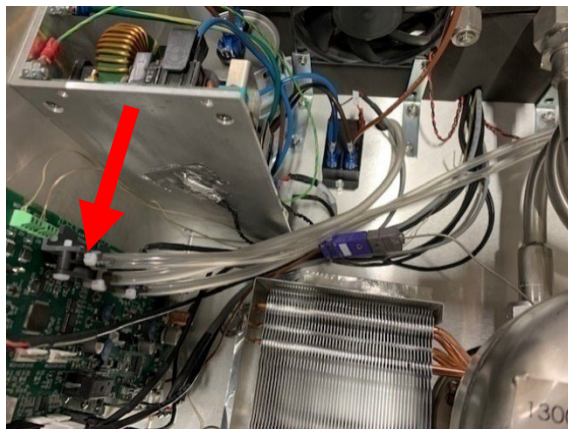

correct location on the control board.

8. Hand tighten each nut and then tighten a $\frac{1}{4}$ turn using the 9/16 wrenches. Use caution not to damage the isolation valve.



9. Reinstall the liquefier shroud.
10. Connect the power supply to power source or outlet.
11. Switch on system power switch followed by the battery backup power switch.

8.13 Relief Valve(s) Replacement

CAUTION: Ensure that the LN₂ supply valve is closed, and the pressure vessel is completely vented before removing the pressure relief valve. Note it may be necessary to refill/top off the pressure vessel.



CAUTION: Installing a pressure relief valve with a different pressure rating could prevent proper operation and lead to a dangerous over pressurized condition. Additionally, this will void any warranty.



1. Verify that the new relief valve(s) is rated to 50 PSI (3.4 bar).
2. Open the Vent valve.
3. Wait for the gas pressure to be lower than 10 psi. The current pressure can be monitored from the GUI.
4. If the Fusion is equipped with pressure relief valve deflector, loosen the deflector clamp, and slide off the deflector.
5. Support the attachment tube with wrench to prevent damage from valve removal. Loosen the pressure relief valve and remove from the plumbing assembly.
6. Install the new relief valve and apply Teflon tape if needed.

NOTE: If the liquid level is at 90% or higher some liquid may come out of the vent valve.



9. Fusion Parts List

Table 9: Replacement Parts

Part Number	Description
21481696	Pressure Relief Valve
21183724	Fusion LID with magnetic contact
20763936	Fusion LID FOAM GASKET
21287912	Dewar Neck Gasket (O-Ring)
20570663	RTD Temperature sensor
21205789	Temperature sensor rubber plug (Yellow Plug)
11499812	Muffler 1/4"NPT
21081273	Battery backup cell, 2 required
2S132K-30252-A	Fan with harness
21837353	FUSE, 15A, 250VAC Qty 3
21836932	TUBE SERVICE KIT (Contains three hoses)
4810179	Step anti-slip strips, 12 feet
1110072	Male Connector, CGA 295, 1/2" ODT X 3/8" MPT for LN ₂ transfer hose

10. Technical Specifications

10.1 Product Specifications

Specification	MVE Fusion 800 Series
Safety for Electrical Equipment and Lab Use	IEC 60601-1-2 Compliant ETL marked for use in the United States and Canada according to: UL 61010-1:2012 (Edition 3.0) CSA/CAN 22.2 #61010-1:2012 (Edition 3.0) ASME Section VIII (Cryogen pressure vessel) Pressure Equipment Directive (PED) 2014/68/EU
Physical Dimensions (approximate)	Height: 60 inches (1524 mm) Width: 33.2 inches (844 mm) Depth: 36 inches (915 mm) Weight (Empty): 500 lb. (226 kg) est. Weight (Full): 650 lb. (295 kg) without racks est. Unit should be placed with 12 inches (305 mm) clearance on all sides.
Electrical Power	System Power: Class I, 9 A, 110-130 V, 58-62Hz Consumption: ~950 W (Maximum) NOTE: MVE recommends the use of a dedicated 15-amp circuit breaker outlet for operating one Fusion. Note generator power may be inconsistent as Fusion's electronics can experience voltage fluctuations so avoid wall outlets that are connected to emergency generator power if possible.





Specification	MVE Fusion 800 Series
	Plug in the power supply to an appropriate wall outlet with the proper AC voltage. The use of an un-interruptible power supply (UPS) is highly recommended to ensure voltage regulation, surge protection and power conditioning. Contact MVE Technical Service for recommendations.
Environmental Humidity Operating Conditions	<p>Temperature: 18°C – 25°C (65°F – 77°F) Humidity: ≤50% (non-condensing) Pressure: 8.2 PSI (57.2 kPa) to 14.7 PSI (101 kPa) Altitude up to 344 m (1129 ft) Indoor use (IPX-1) Overvoltage Category II Use in environment with Pollution Degree 2</p> <p>NOTE: The ambient operating temperature has a direct impact on the amount of the cryocooler’s cooling capacity. Heat pumped by the cryocooler must be rejected to the ambient environment. Running for prolonged periods of time in an ambient environment that over 77°F (25°C), and/or high humidity conditions, may impact freezer performance and temperature. Moisture ingress can occur when the lid on the Fusion freezer is opened. Limiting (as best possible) the relative humidity the in room can help minimize ice buildup around the neck/lid.</p> <p>CAUTION: Do not place the Fusion near any device that emits heat.</p>
Standard Performance	<p>Sample temperatures -150°C or colder at the top box unless:</p> <ul style="list-style-type: none"> • More than two warm 13-2 large racks or equivalent thermal load are added to the freezer. • Main AC power is lost for more than 5 days or lid left open for longer than 15 minutes. • Loss of power to the cryocooler
Pressure Vessel	<p>Cryogen: Liquid Nitrogen Volume: ≈45 Liters Pressure Relief Valves: 50 PSI (± 5%)</p>
Sample Storage Specifications	<p>Number of Racks:</p> <ul style="list-style-type: none"> • 20 Standard 13-2 racks (13-shelves for 2" boxes), plus 16 Mini 13-2 racks. • Number of Vials: 26,000 based on Internally threaded vials (standard racks only; 31,200 with mini racks) • Vial type: 0.5 to 2mL
Operating System	LCD Android based GUI

These devices have been tested to comply with UL 61010-1:2012 Ed.3, CSA C22.2#61010-1:2012 Ed.3 +G1, and IEC 60601-1-2.



10.2 Product Environmental Requirements

Environmental Technical Specifications

Table 10: Environmental Technical Specifications

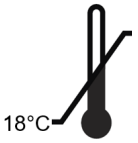
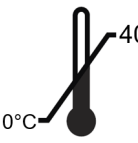
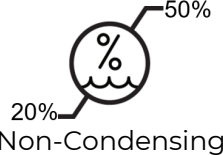
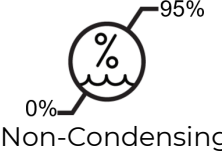
Environmental Condition	Ideal Operating	Storage and Transport
Temperature	 18°C – 25°C	 0°C – 40°C
Relative Humidity	 20% – 50% Non-Condensing	 0% – 95% Non-Condensing

Ambient Temperature and Relative Humidity

MVE cryogenic freezers and controllers are designed to be operated in environments near room temperature 18°C – 25°C (65°F – 77°F) and a relative humidity below 50%. The relative humidity should be maintained low enough so that condensation does not form on the electronics. Elevated humidity levels can lead to excessive condensation and frost on and around the lid. In situations where the relative humidity is high and uncontrollable, the lid should be routinely wiped dry to prevent ice formation. Should significant ice formation develop, thaw as necessary. Refer to the Preventative Maintenance procedures for details.

Atmospheric Pressure

MVE cryogenic freezers are designed to be operated in environments with atmospheric pressure range of 8.2 psi (57.2 kPa) to 14.7 psi (101 kPa).

Thermal Load

The MVE Fusion freezer utilizes a pulse-tube, acoustic-Stirling cryocooler to remove heat from the gaseous nitrogen within the pressure vessel converting it back into a liquid. To do so, the system must reject this pumped heat out into the ambient air. Under steady state conditions, the nominal heat output of the system is 2550 btu/hr.

10.3 Electromagnetic Requirements

This device complies with IEC 60601-1-2.

10.4 Essential Performance and Disturbances

Essential performance of the MVE Fusion Freezer, with the addition of LN₂ to the system, is to maintain cryogenic temperatures during storage for the preservation of human or animal biological products, samples, or specimens (e.g., blood, blood products, cells, tissues, etc.).

The MVE Fusion will monitor and output freezer temperature by front LCD touchscreen. It will also alarm when freezer is above of user defined temperature (default $>-150^{\circ}\text{C}$).

WARNING: If performance is lost or degraded due to EM Disturbances, MVE Fusion can maintain cryogenic temperatures for up to 5 days (If storage vessel is full), afterwards temperatures will rise.



=WARNING: If EM Disturbances occur, please attempt to reboot the MVE Fusion by power cycling the system. Please contact the Distributor or MVE Technical Service if problems continue.



CAUTION: Read all safety information before operating this equipment.

WARNING: Do not modify this equipment without authorization of MVE.



WARNING: Use of this equipment adjacent to or stacked with other equipment should be avoided because it could result in improper operation. If such use is required, this equipment and the other equipment should be observed to verify that they are operating normally.



WARNING: Portable RF communications equipment (including peripherals such as antenna cables and external antennas) should be used no closer than 30 cm (12 inches) to any part of the MVE Fusion Freezer, including cables specified by the manufacturer. Otherwise, degradation of the performance of this equipment could result.



If any persisting alarms occur, please contact your authorized MVE Distributor or Customer / Technical Service.

11. Taking Fusion Out of Service

SAFETY NOTE: The LN₂ fill and vent valves on empty pressure vessel should always be kept closed to protect the Fusion freezer from moisture ingress to within the pressure vessel. Always keep the Fusion freezer and plumbing connections clean and free from grease and oil.

WARNING: Before implementing described below, review Safety Information section 1 of this technical manual.

CAUTION: If storing the Fusion freezer long term, the equipment must be completely dry of all moisture. The presence of moisture/ice may prevent the Fusion's



pressure vessel from being refilled. If storing Fusion freezer for a few days before reinstalling, ensure positive nitrogen gas pressure and no air enters the pressure vessel after it is drained.

There is no system shutdown option in the firmware. Consider downloading alarm history prior to taking freezer out of service.

1. Switch off the battery backup switch followed by the system power switch.
2. Disconnect the power cord from electrical power source or outlet.

Valve Closed



3. Close the isolation valves.
4. Remove the freezer's access lid.
5. Remove the racks from sample storage area.
6. Move and lock the stairs into the stowed position.
7. Move the freezer to an area where the LN₂ can be drained.
8. Open the fill valve (counterclockwise) to drain the LN₂.
9. Once drained, close (clockwise) the fill valve. Some slight venting may occur from the pressure relief valve after closing the fill valve.



LN₂ Fill Valve

Continue with the following steps for long term storage.

10. Leave the freezer lid off.
11. Raise the turn tray bottom access panel.
12. Place a fan on neck of the Fusion to blow ambient air into the sample storage area for at least 24 hours.



13. Connect a LN₂ transfer hose to N₂ GAS USE on side of a supply tank, 22-35psi (1.5 to 2.4 bar), adaptor fitting, PN 1110072, Male Connector – CGA 295 – 1/2" ODT X 3/8" MPT.



14. Connect the other end of the LN₂ transfer hose to the Fusion LN₂ fill port.
15. Open the supply tank's GAS USE valve.
16. Open the Fusion's fill port. (venting may occur from Relief valve on supply tank).
17. Open the Fusion's vent port
18. Allow dry N₂ gas to run through the Fusion's cryogen storage vessel for about 30 minutes.
19. Close the Fusion's vent port.
20. Close the Fusion's fill port (will help maintain positive nitrogen gas pressure in pressure vessel).
21. Close the supply tank's GAS USE valve.

12. End of Life Disposal

The Fusion freezer should be returned to MVE at the end of its useful life for proper disposal. Please contact an MVE Customer or Technical Service Representative to discuss the arrangements.

Freezers used to store biological materials require decontamination prior to disposal. Contact MVE for decontamination information.



Local or national environmental laws and regulations may prohibit disposal of electrical and/or electronic equipment such as the controller. Contact the local city or town offices for instructions on proper disposal of electrical or electronic equipment. Alternately, MVE may be contacted for disposal information.



13. Customer Service

Table 11: Contact Information

Location	Phone	Fax	Email
The Americas	844-MVE-CRYO +1 844-683-2796	+1 470 552 2200	customerservice.usa@mvebio.com techservice@mvebio.com
Asia, Australia, Pacific Rim	Asia: +1 844-683-2796 Australia: +61 (2) 974 94333	+61 (2) 974 94666	csasia@mvebio.com techservice@mvebio.com
Europe	+44 (0) 7718 488236	Not Available	customerservice.europe@mvebio.com techservice@mvebio.com



MVE Biological Solutions US, LLC
3055, Torrington Dr
Ball Ground, GA 30107 USA.
www.mvebio.com



MVE Biological Solutions US, LLC reserves the right to discontinue its products, or change the prices, materials, equipment, quality, descriptions, specifications and/or processes to its products at any time without prior notice and with no further obligation or consequence. All rights not expressly stated herein are reserved by us, as applicable. Copyright © 2025 MVE Biological Solutions US, LLC.